

**KINGSINE**

# **KRT Software Operation Guide**

V3.9.0

Kingsine Electric Automation Co.,Ltd. © 1999-2022



Dear Customers:

Thank you for your using Kingsine brand protection relay testing system. Hope that the technical data and help information in the manual will be provided to you as detailed as possible about how to use Kingsine products. Meanwhile, we shall be much appreciated to receiving any views about this manual from all the readers and all the experts in the line of relay testing. Should any business advice or technical support service required, then you are welcome to call us or visit our website.

Notes:

Please concern the latest information on our website to get the latest and most helpful information for your work. The function and pictures in this manual should be based on the real published product.

# KRT Software Operation Guide

Kingsine Electric Automation Co.,Ltd. © 1999-2022

All rights reserved. No parts of this work may be reproduced in any form or by any means - graphic, electronic, or mechanical, including photocopying, recording, taping, or information storage and retrieval systems - without the written permission of the publisher.

Products that are referred to in this document may be either trademarks and/or registered trademarks of the respective owners. The publisher and the author make no claim to these trademarks.

While every precaution has been taken in the preparation of this document, the publisher and the author assume no responsibility for errors or omissions, or for damages resulting from the use of information contained in this document or from the use of programs and source code that may accompany it. In no event shall the publisher and the author be liable for any loss of profit or any other commercial damage caused or alleged to have been caused directly or indirectly by this document.

Printed: Jan, 2018

## **Publisher**

*Kingsine Electric Automation Co.,Ltd*

## **Managing Editor**

*Xiong Zhihui*

## **Technical Editors**

*Li Zhi*

*Yang XueKe*

*Gao Yan*

## **Team Coordinator**

*Jin Tone*

# Table of Contents

<b>Part 1 KRT Software User Guide</b>	<b>8</b>
<b>1.1 Instructions</b>	<b>8</b>
1.1.1 Basic Concept	8
1.1.2 Installation	12
1.1.3 Communication Setting	13
<b>1.2 Start Page</b>	<b>15</b>
1.2.1 Test Modules	15
1.2.2 Test Template	16
1.2.3 Setting	16
Hardware	16
Software	17
UserInfo	17
Phase	18
Default Value	20
Binary	20
Directory	22
AuxDC	22
1.2.4 Support	23
Calibration	23
Upgrade	23
License	24
<b>1.3 Test Modules Overview</b>	<b>25</b>
1.3.1 Menu bar	25
1.3.2 Status bar	27
1.3.3 Test Center	28
1.3.4 Test view, State Table view, Setting view	31
1.3.5 Vector View	31
1.3.6 Other View	32
<b>1.4 System config</b>	<b>32</b>
1.4.1 Device Config	33
1.4.2 Amplifier output connection	35
1.4.3 IEC61850 mode	36
IEC61850-9-1 /2	37
1.4.4 Binary input & outputs	38
GOOSE mode	38
Hard Contacts (Relay type)	39
<b>1.5 Test Object</b>	<b>39</b>
1.5.1 Test Object Converter	41
1.5.2 Device object	42
1.5.3 Distance Object	43
1.5.4 Overcurrent Object	45
1.5.5 Differential Object	46
Protection Device Tab	46
Characteristic Definition Tab	49
Harmonic Tab	49
1.5.6 Synchronizer Object	49
1.5.7 Circuit Breaker Object	50
<b>1.6 AC test</b>	<b>50</b>

1.6.1	Set Mode of Analog Output .....	52
1.6.2	Ramping mode .....	53
1.6.3	Fault Trigger Logic .....	54
1.6.4	Result View .....	55
1.6.5	Impedance View .....	55
1.6.6	Time Signal View .....	55
1.6.7	Wiring View .....	56
1.7	Ramping .....	56
1.7.1	Set Mode of Analog Output .....	58
1.7.2	Ramping mode .....	59
1.7.3	Fault Trigger Logic .....	59
1.7.4	Results view .....	60
1.7.5	Impedance View .....	61
1.7.6	Time Signal View .....	61
1.8	StateSequencer .....	62
1.8.1	States Menu Bar .....	62
1.8.2	State Table .....	62
1.8.3	Setting View .....	63
	Analog Output.....	63
	Trigger Condition.....	64
	Binary Output Setting.....	65
	General .....	65
	Others .....	65
1.8.4	Other View .....	65
	Result Evaluation.....	66
	Time evaluation.....	66
	State evaluation.....	67
	Time Signal View .....	68
	Impedance View .....	68
	Wiring View .....	68
1.9	Harmonic .....	68
1.9.1	Harmonic Characteristic .....	70
1.9.2	Fault Trigger Logic .....	70
1.9.3	Result View .....	71
1.10	Frequency Test .....	71
1.10.1	Under-Frequency mode .....	72
	Frequency.....	73
	Time .....	74
	df/dt Latch.....	75
	Under-U Latch.....	76
	Under-I Latch.....	77
1.10.2	Under-Voltage mode .....	78
	Voltage .....	78
	Time .....	79
	dv/dt Latch.....	80
	Under-I Latch.....	81
1.11	Transplay .....	82
1.11.1	Channels Combine .....	83
1.11.2	Binary Output .....	84
1.11.3	Advance .....	84
1.11.4	Information .....	84
1.12	Distance .....	84
1.12.1	Shot Test .....	85
1.12.2	Search Test .....	86

1.12.3	Test Parameter .....	86
1.12.4	Binary setting .....	88
1.12.5	Impedance View .....	89
1.12.6	Time Signal View .....	90
1.12.7	Z/t Characteristic Diagram .....	90
<b>1.13</b>	<b>Overcurrent .....</b>	<b>90</b>
1.13.1	Test Point .....	91
1.13.2	Setting Parameter .....	91
1.13.3	Binary setting .....	92
1.13.4	Overcurrent Characteristic .....	93
1.13.5	Time Signal View .....	93
<b>1.14</b>	<b>Differential .....</b>	<b>94</b>
1.14.1	<b>Bias Curve Diff. ....</b>	<b>94</b>
	Shot Test tab.....	95
	Search Test tab.....	96
	General tab.....	97
1.14.2	<b>Harmonic Restraint .....</b>	<b>97</b>
	Shot Test tab.....	99
	Search Test tab.....	99
	General tab.....	100
<b>1.15</b>	<b>Reclose .....</b>	<b>101</b>
1.15.1	Test .....	101
1.15.2	Fault Transfer .....	102
1.15.3	Parameters .....	102
1.15.4	Binary Setting .....	104
1.15.5	Impedance View .....	105
1.15.6	Z/t Characteristic Diagram .....	105
<b>1.16</b>	<b>Synchronizer .....</b>	<b>105</b>
1.16.1	Action voltage .....	106
1.16.2	Action Frequency .....	107
1.16.3	Angle / Time .....	108
1.16.4	Electric Zero .....	108
1.16.5	Pulse Width Control-V .....	108
1.16.6	Pulse Width Control-F .....	108
1.16.7	Slips acceleration latch .....	109
1.16.8	Auto Synchronizer .....	109
1.16.9	Binary setting .....	109
<b>1.17</b>	<b>Power Swing .....</b>	<b>110</b>
1.17.1	Test Parameter .....	111
1.17.2	System Model .....	112
1.17.3	Surge Diagram .....	113
<b>1.18</b>	<b>Energy Meter .....</b>	<b>113</b>

# 1 KRT Software User Guide

## 1.1 Instructions

### 1.1.1 Basic Concept

KRT can be considered as a **"simple but still powerful"** software for testing most of the complex protection relays, energy meters & transducers etc. KRT finds its application in power utilities as well as manufacturer's place. Kingsine's approach is to equip its customers with the all in one software that concludes all the advanced features. We have a fully automatic "test center" facility to test even the most typical multifunctional relays on a single click.

The reason behind KRT's success lies in **"your priceless feedback"**.

Yes, We have received and successfully incorporated numerous feedback from our esteemed customers & team mates, making KRT a grand success. We believe that "perfection is the continuous process" & we are always open to receiving better ideas from your side. (contact us on email: [tone@kingsine.com.cn](mailto:tone@kingsine.com.cn)).

While using KRT a user can test -:

- Complex relays using basic AC/DC Test Module .
- Complex relays using Advance Test Modules
- Multifunctional Relays ( Using test center )
- IEC61850 enabled IED's ( GOOSE & Sampled Values )
- Energy Meters
- Transducers
- Merging Units



## Diagram of KRT

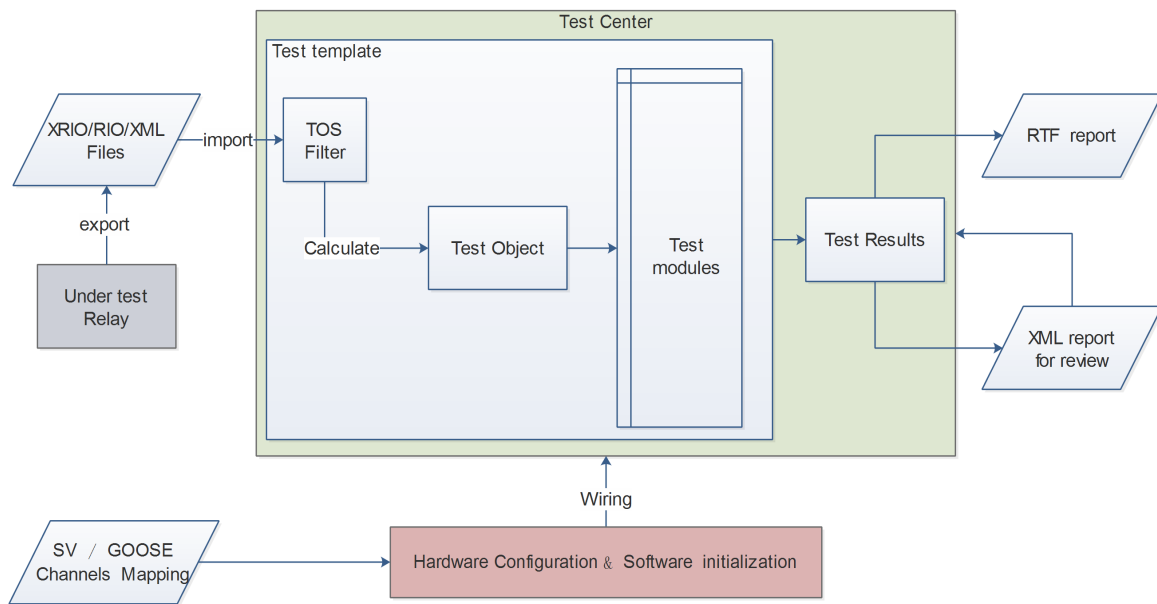

## Eagle's Eye View - Relay Testing

Relay is a switching device that issues a trip command to the Circuit Breaker during abnormal fault conditions.

A Relay receives the input signals from CT's/ PT's and its program calculates the fault conditions as per application. It issues a trip command to the Circuit Breaker upon detecting a faulty condition.

Relay trip time (dT) is the time elapsed between the "Arrival" of fault condition and the "Issuing" Trip command

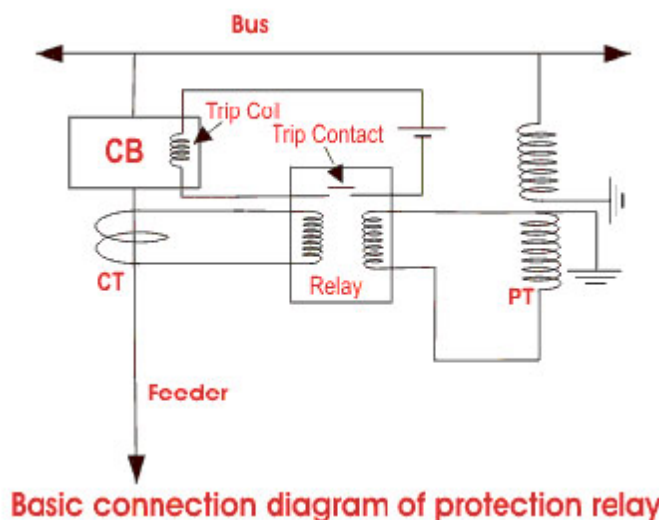

## Relay testing ( General Steps )

**Step 1:** Relay Testing Kit injects fault in the form of I & V on respective CT & PT points of Relay under test. The Timer of Relay

Testing Kit **starts** at the moment of fault injection.

**Step 2:** Relay senses the fault & issues the trip command, its trip timing must depend on the time characteristics of relay settings.

**Step 3:** Relay Testing Kit receives the trip command from Relay & **Stops** the timer.

**Step 4:** The measured tripping time & fault actuating characteristics are compared with respect to the expected settings by Engineer. The testing results should be accepted as long as they are within the tolerance range.

### Kingsine's " COM " Terminology

To start with KRT, user has to remember a simple "**COM**" terminology:

- C - **C**onnect & **C**onfigure
- O - Define Test **O**bject
- M - Test **M**odule

#### 1. **Connect & Configure -:**

**Establishing connection** is the first step where the user connects the relay test kit hardware with the KRT software (installed on PC). Once the kit is connected, user can see "**connected**" status on the top right corner of the software.

**Second step is to "Configure"**, this option is used by the user to configure various settings as shown below -:

- The Analog I/P & O/P rating & characteristics (In System )
- The binary I/P & O/P characteristics (In System)
- The GOOSE & Sample Value channels (In System)
- Naming Terminology for all Analog & Binary channels (In Software).
- Select the voltage rating for Auxiliary DC Voltage Source (In Aux DC )

#### 2. **Define Test Object**

Each device under test (mostly relay) has respective "test settings". All these test object's settings are mentioned in this "Test Object" section. Test Object section is used to -:

a) Define relay's nominal & fault conditions .

b) Define relay's expected test results W.R.T those fault conditions. Once a test is done, actual test results are then automatically compared with the expected results from "Test Object data". If the results are within the tolerance band of "Test Object Settings" then the evaluation passes (else fails).

c) Based on the values of "**Test Object**" a visual test graphic is

- simulated for fault parameters, this helps the user to
- directly inject the fault by clicking on that graph.
  - directly see the status of result (pass/fail) on the graph .

### 3. Define Test Module

This is the final step of the testing where **the user enters in this respective test module and injects the fault**. This section generally defines the following parameters -:

- Fault Characteristics
- Time delays (prefault time, fault time & post fault time)
- Binary Inputs & Outputs Trigger Logic
- Visual Graphs defining faults under test
- Different views such as vector view, Report View, Connection View, Time View etc.

#### 3 method to easy start a test:

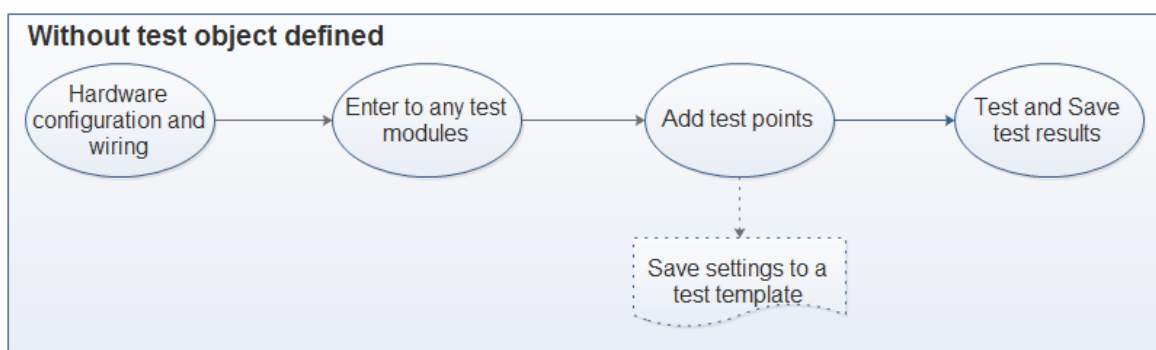
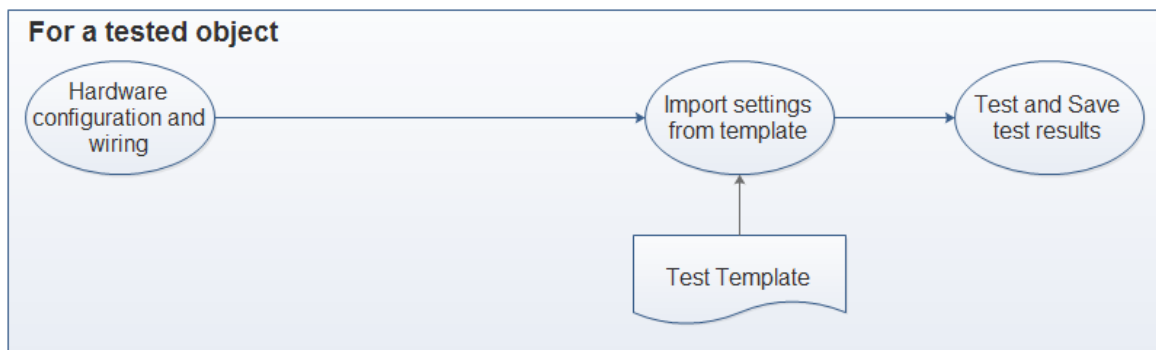
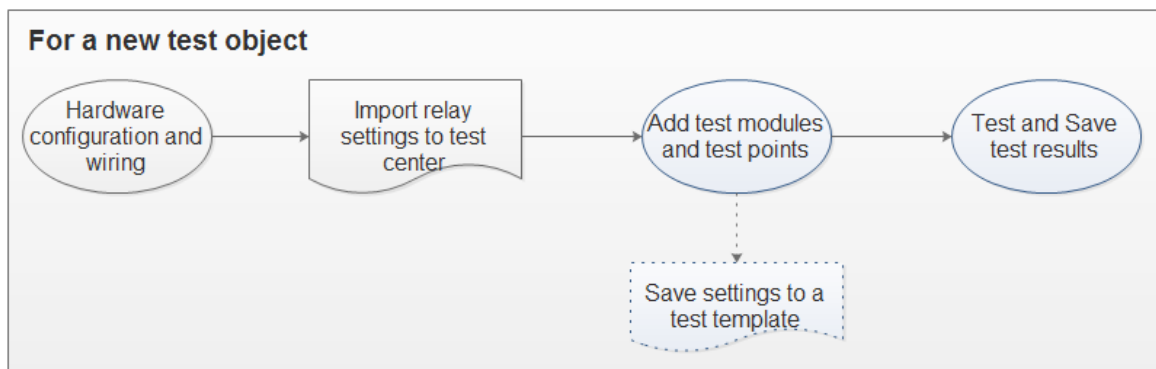

## Different ways to import the settings .

KRT software is designed in a way that user can create the test plans & test settings at each step. These settings/ test plans can be easily imported in the software making relay testing an effortless job to do.

According to the below schematic, a user can clearly see the flow diagram during relay testing using KRT. Please note that the Yellow Coloured Boxes are the stages where user can save/ import the settings directly

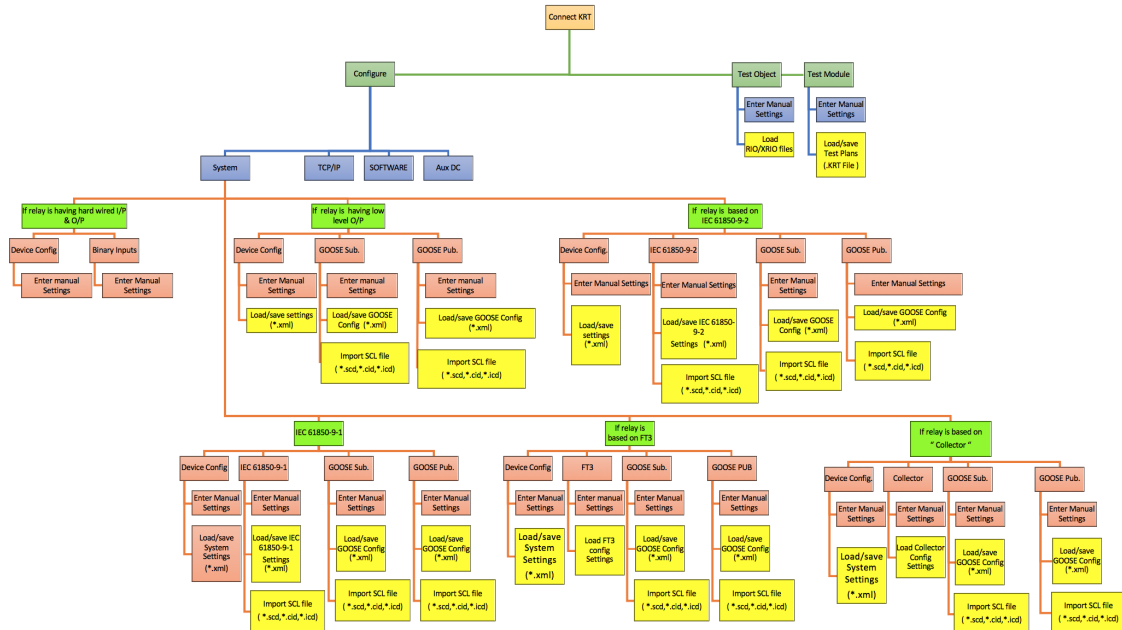

### 1.1.2 Installation

#### Operating system requirement

System requirement:

- Windows 7 sp1(32bit/64bit + .net framework V4.0
- Windows 8 or 8.1(64bit), any SP
- Windows 10
- Administration or Power User rights for the installation
- A screen resolution of 1024x768 or higher

#### Installation

- Make sure the requirements are satisfied
- Run the installer (KRT Vx.x.xx.exe) with admin privileges.  
Note: Right click the INSTALLER and run the same as administrator.
- Select the Language for installation from Chinese (Simplified) or English (US).
- Follow the on-screen wizard instructions until it's successfully

installed.

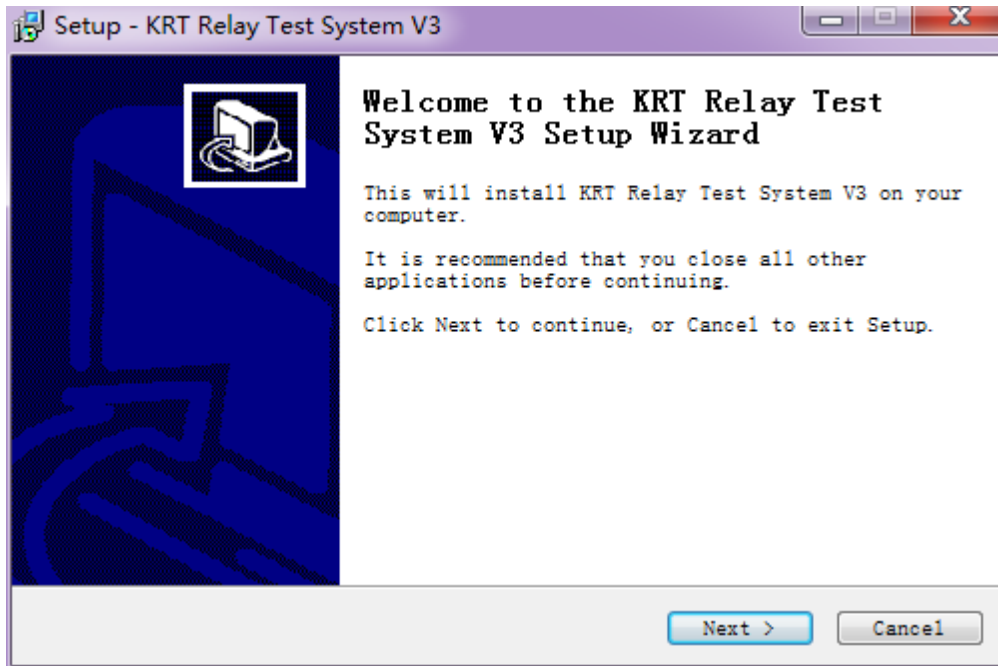

### 1.1.3 Communication Setting

#### IP address setting:

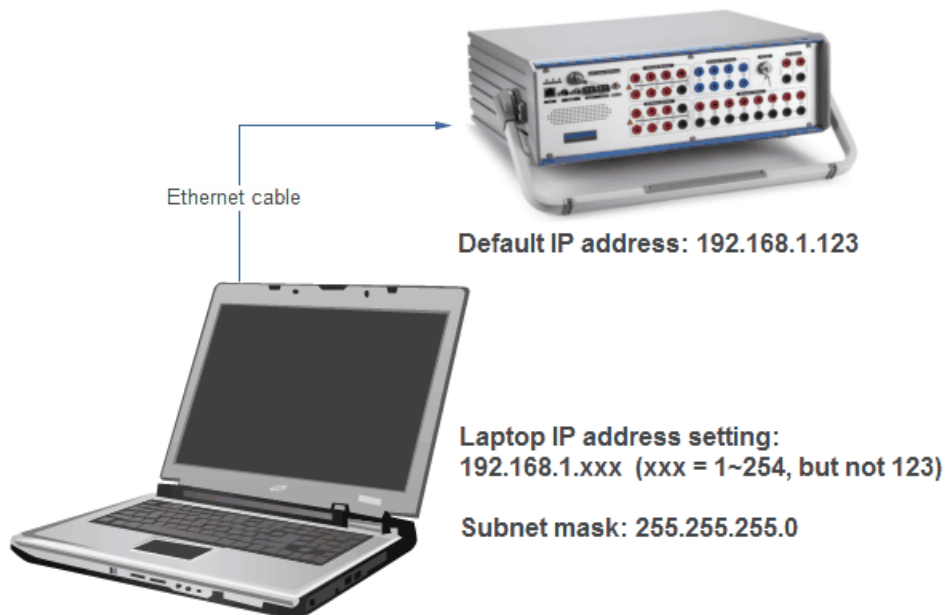

1. The default IP address of the relay test kit is 192.168.1.123
2. Set the IP address of the laptop to the same network segment, like: 192.168.1. xxx ;  
(xxx can be 1~254, but can not be the same as the last segment of the test kit IP address. In this example, the IP address cannot be set as **192.168.1.123**)  
Subnet mask of laptop should be set as: 255.255.255.0
3. Use Ethernet cable connect K3163i and laptop.

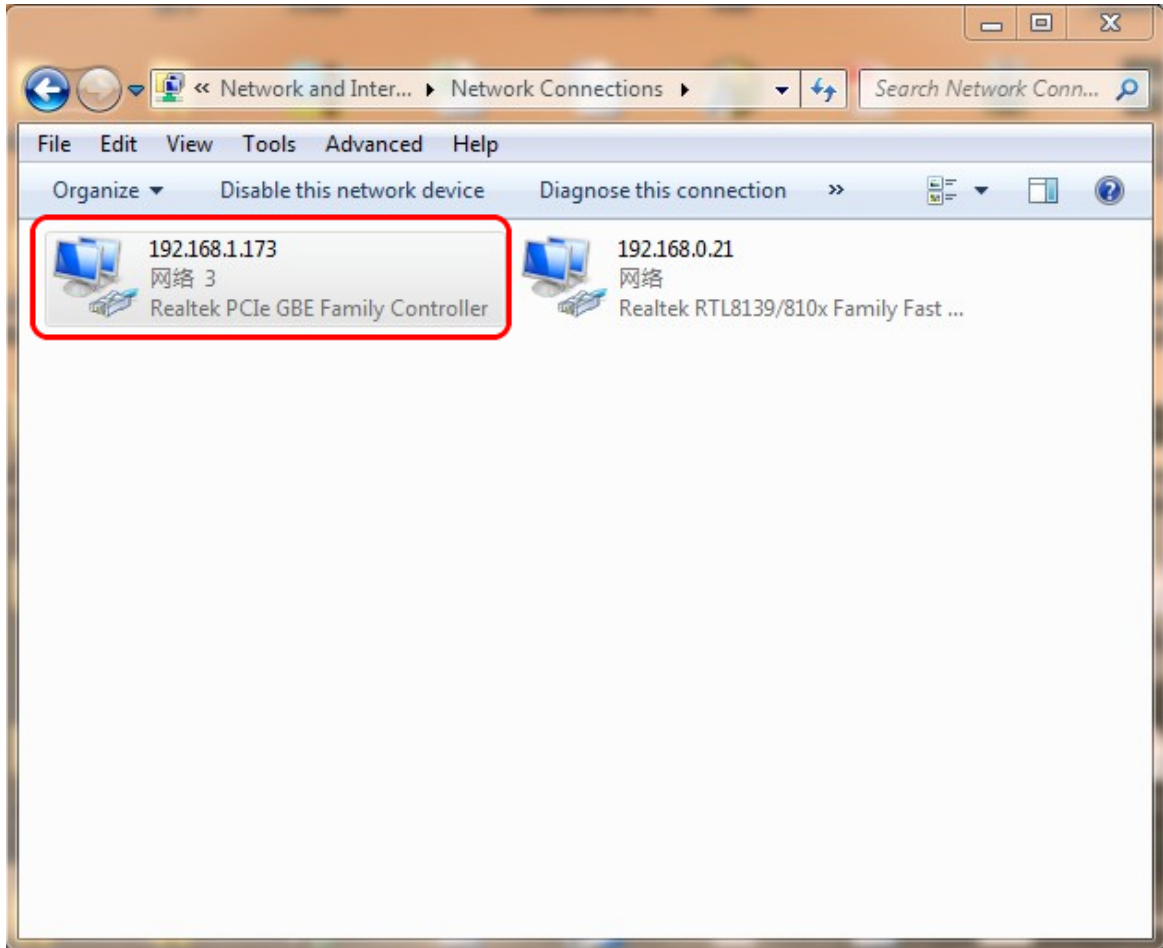

See the Hardware instructions about Ethernet port, and TCP/IP

The connection status will be automatically displayed on the upper right corner of KRT Start page.

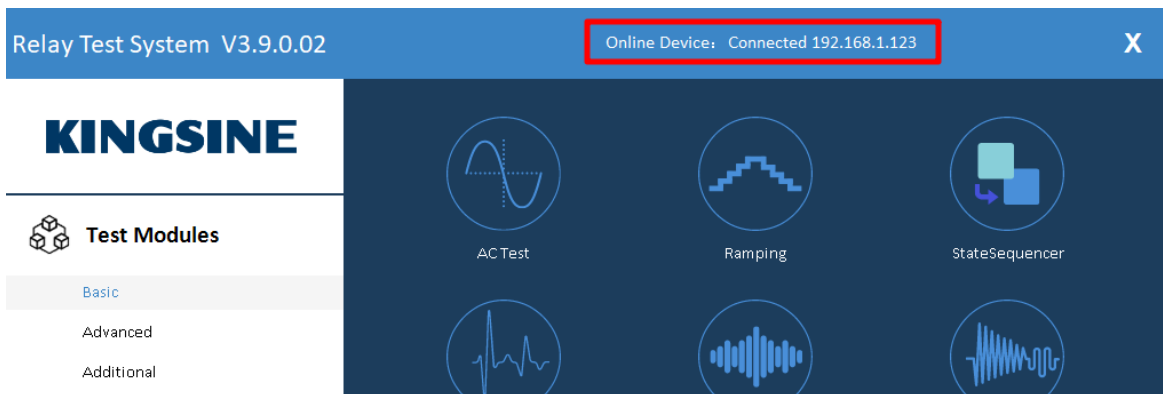

**Note:** If the IP address of the laptop and the relay test kit is not in the same network segment, then the KRT software will show the IP of test kit but will not connect successfully. Instead, it will continuously attempt to establish connection. The user needs to check the IP address of the local laptop and whether the system firewall has adopted a policy that disables access to the network for KRT.

## 1.2 Start Page

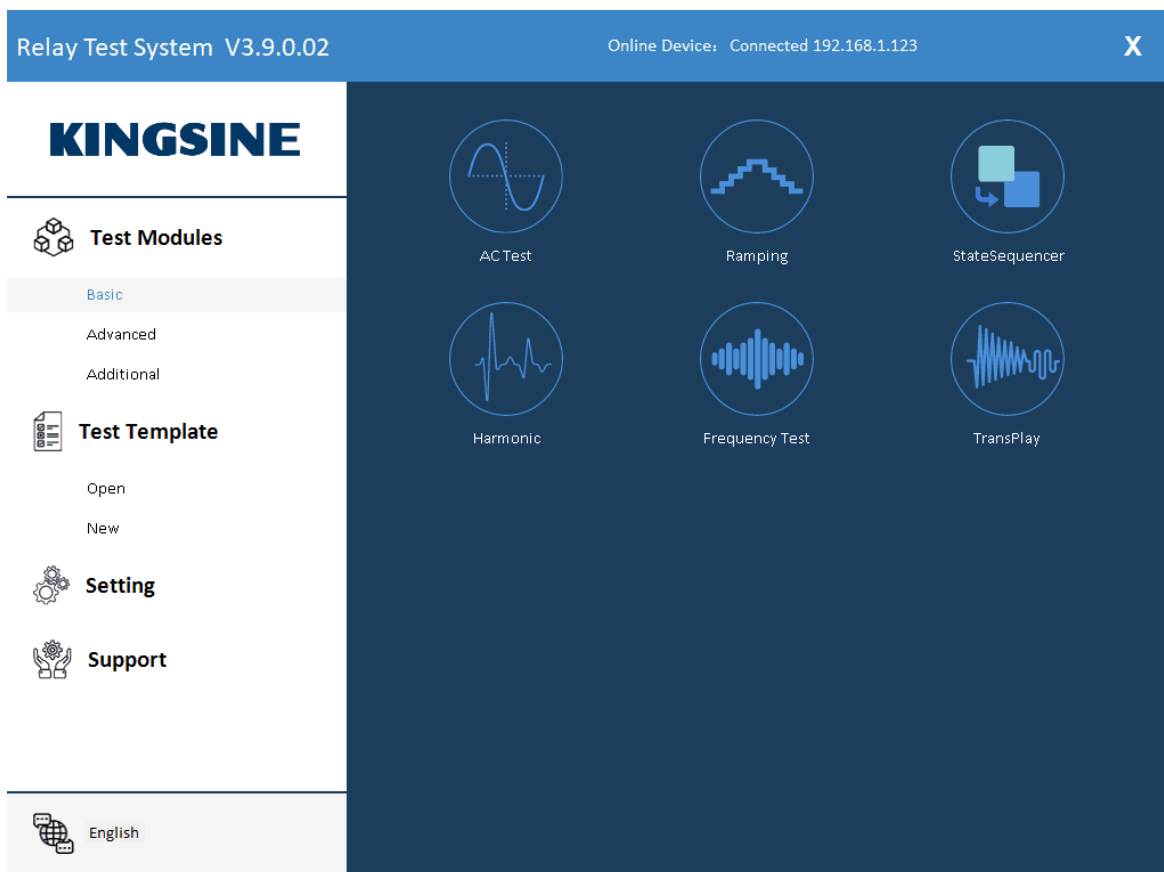

The upper side shows the connection status.

On the left side shows the category of test modules, include Basic, Advance, MU, Additional, [Test Template](#)<sup>16</sup>, Setting, Support, and Language & Theme selection.

See: Configure, Support

### 1.2.1 Test Modules

Basic	AC test, Ramping, StateSequencer, Harmonic, Frequency Test, Transplay
Advanced	Distance, Overcurrent, Differential, Harmonic Restrain, Diff Configuration, Reclose, Synchronize, PowerSwing etc.
Additional	Transducer, Energy Note: The license of these functions are authorized by hardware authorization. Press "License" from "Support" panel to see the detail hardware authorization.

## 1.2.2 Test Template

Test Template provide manage, create, and edit test templates.

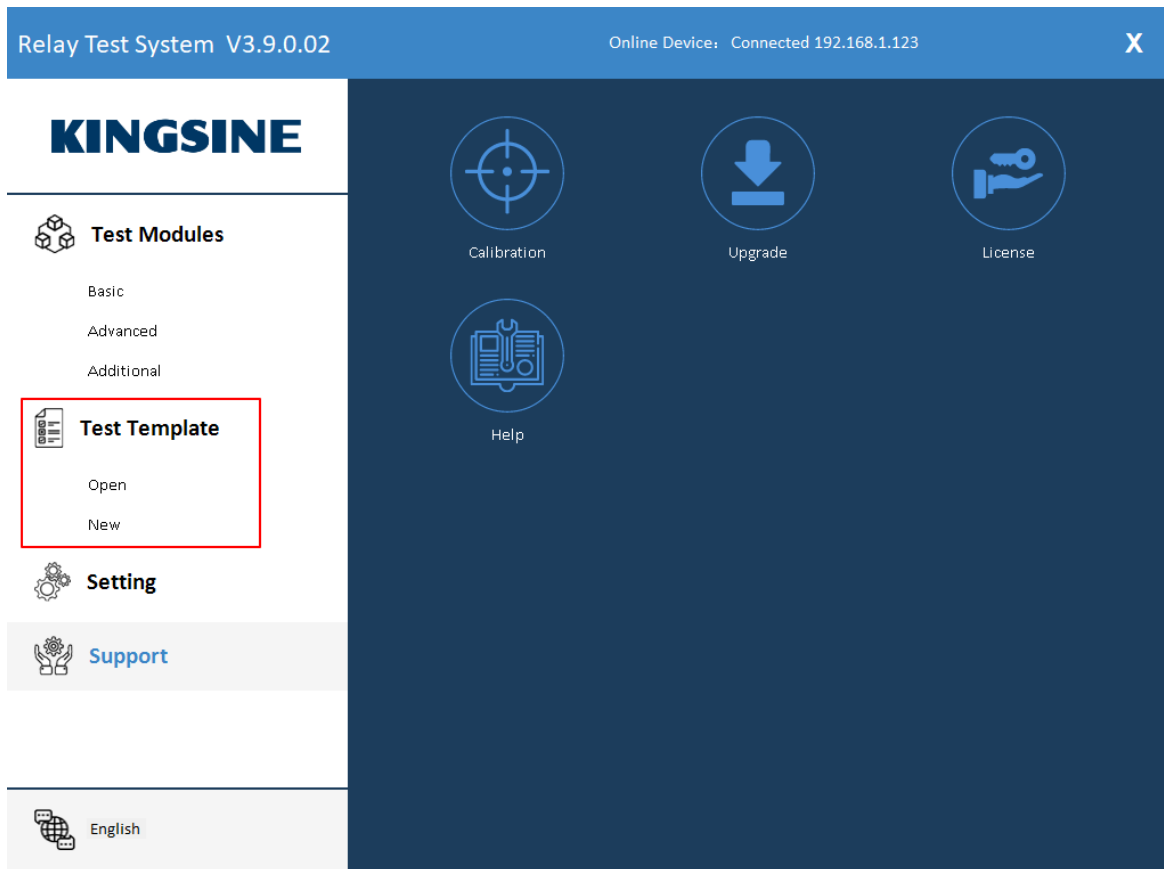

## 1.2.3 Setting

Setting panel include "Hardware", "Software" and "AuxDC".

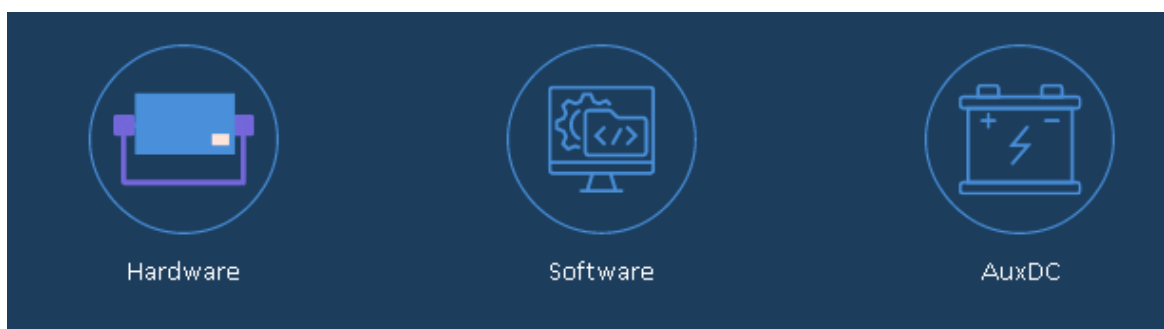

### 1.2.3.1 Hardware

In "Hardware", user can:

1. Edit the IP address of relay testing kit in "Hardware"
2. While in **disconnected** status, user can import an other firmware configuration to simulate different relay tester model for software function demo and study.



### 3. Check all the firmware configurations.

ID	IP Address	Mac Address	Gate Way	Subnet	State	
<input type="checkbox"/> 0	192.168.1.123	00:0A:35:31:97:51	192.168.1.1	255.255.255.0	0	

UnConnected Device

	Set Item	Set Value	Set Value	Set Value	Set Value
▶ Device	Device Code:	201087065			
	Device Kind:	K6099_K3063IHP			
	Device Date:	20220505			
	PAOACISwitches(A):	3.000A	35.000A		
	PAOACVSwitches(V):	30.000V	310.000V		
	PAODCISwitches(A):	3.000A	35.000A		
	PAODCVSwitches(V):	30.000V	310.000V		
	LLOVSwitches(V):	0.800V	8.000V		
	BIMVSwitches(V):	600.000V	60.000V	10.000V	1.000V
	BITVSwitches(V):	300.000V	30.000V	3.000V	1.000V
	BTMISwitches(V):	10.000V	1.000V		
	BTMISwitches(A):	0.020A	0.001A		
	System Frequency(Hz):	50.000Hz			
	PAOICount(3/6/9/12):	6			
	PAOVCount(4/6/7/10/13):	4			
	PAOAuxDCV(0:G2UBUC/1:G2UB/2:G3UBUC/3:G3UB):	2			
	PAOKind(0:Analog/1:Number):	0			

### 1.2.3.2 Software

#### 1.2.3.2.1 UserInfo

UserInfo defined by testing engineer, it will generate and export in the reports.

UserInfo	Phase	DefaultValue	Binary	Directory
<b>TestInfo</b>				
User Name <input type="text"/>				
Company <input type="text"/>				







#### 1.2.3.2.2 Phase

Allow user set the phase marking and customize color display in vector view.

Phase

	Group 1	Group 2	Group 3	Group 4	Group 5	Group 6
Phase1	A	X	R	U	E	O
Phase2	B	Y	S	V	F	P
Phase3	C	Z	T	W	G	Q
Neutral	N	N	N	N	N	N
Aux	Aux					

Phase Color

	Voltage	Current
<input type="button" value="Color Identical"/>	Phase1 	
	Phase2 	
	Phase3 	
	Neutral 	

### 1.2.3.2.3 Default Value

Set the global value of default voltage, current and frequency.

UserInfo	Phase	Default Value	Binary	Directory
Default Value				
Voltage(P-E)		<input type="text" value="57.735V"/>	Frequency <input type="text" value="50.000Hz"/>	
Current		<input type="text" value="1.000A"/>		

### 1.2.3.2.4 Binary

Set the marking of Binary input & output.

Set the mapping relations of virtual binary input.

SoftWare

UserInfo | Phase | Default Value | **Binary** | Directory

Options

Default Binary  Define Binary

Binary OutPut		Binary Input		
Port	Label	Port	Label	Virtual Enable
Binary Output1	1	Binary Input1	1	<input checked="" type="checkbox"/>
Binary Output2	2	Binary Input2	2	<input type="checkbox"/>
Binary Output3	3	Binary Input3	3	<input type="checkbox"/>
Binary Output4	4	Binary Input4	4	<input type="checkbox"/>
Binary Output5	5	Binary Input5	5	<input type="checkbox"/>
Binary Output6	6	Binary Input6	6	<input type="checkbox"/>
Binary Output7	7	Binary Input7	7	<input type="checkbox"/>
Binary Output8	8	Binary Input8	8	<input type="checkbox"/>
Binary Output9	9	Binary Input9	9	<input type="checkbox"/>
Binary Output10	10	Binary Input10	10	<input type="checkbox"/>
Binary Output11	11	Binary Input11	11	<input type="checkbox"/>
Binary Output12	12	Binary Input12	12	<input type="checkbox"/>
Binary Output13	13	Binary Input13	13	<input type="checkbox"/>
Binary Output14	14	Binary Input14	14	<input type="checkbox"/>

OK Cancel

### 1.2.3.2.5 Directory

Customize working directories.

The screenshot shows a software window with a tabbed interface. The 'Directory' tab is selected and highlighted in blue. Below the tabs, there is a section titled 'Directory Info' containing four rows of configuration options. Each row consists of a label, a text input field with a file path, and a button with three dots (representing a file browser). The paths are: Template Dir (D:\Kingsine\KRTV3\Template), Paramter Dir (D:\Kingsine\KRTV3\Parameter), Report Dir (D:\Kingsine\KRTV3\Report), and Config Dir (D:\Kingsine\KRTV3\SystemConfig).

Label	Path	Action
Template Dir	D:\Kingsine\KRTV3\Template	...
Paramter Dir	D:\Kingsine\KRTV3\Parameter	...
Report Dir	D:\Kingsine\KRTV3\Report	...
Config Dir	D:\Kingsine\KRTV3\SystemConfig	...

### 1.2.3.3 AuxDC

Set the auxiliary DC constant output for testing object working power supply.

This setting can be change on the status bar of all testing modules.

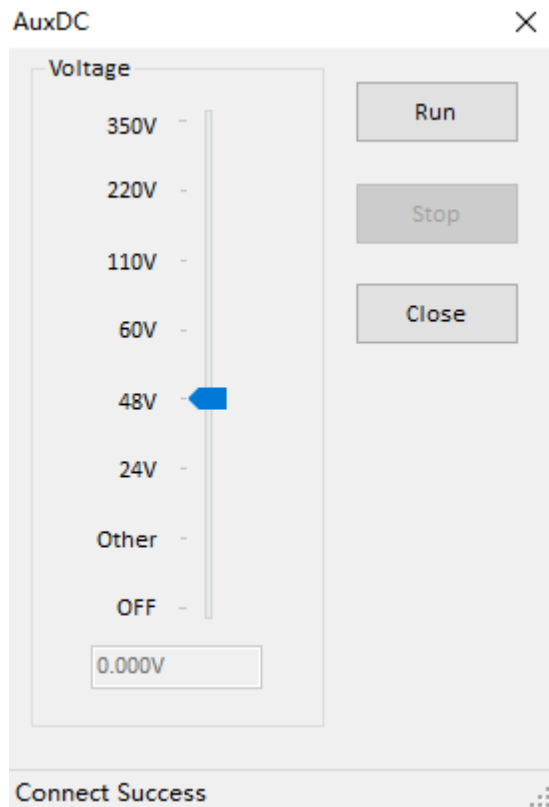

While Auxiliary DC output working, in Start page, the text's color of AuxDC symbol will be in RED; in Status bar, the color of AuxDC symbol will be in GREEN and the output value will shows together.

## 1.2.4 Support

### 1.2.4.1 Calibration

This function only used by authorized engineer for the testing kit parameters calibration.

### 1.2.4.2 Upgrade

Used for "Firmware" upgrade.

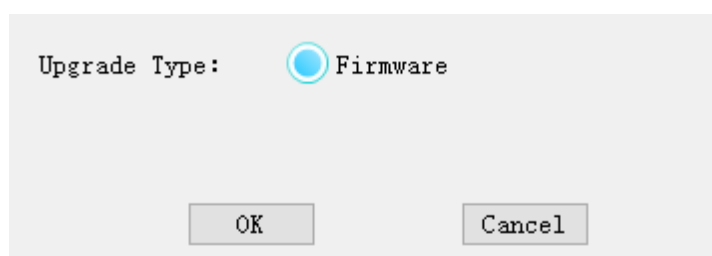

#### Firmware upgrade process

1. Connect the relay test kit and enter to "Upgrade" function;
2. Select the corresponding firmware "Kxxxx\_\*.zip" and press upgrade.

**(The upgrade process needed about 3~10 minutes, do not power off or disconnect the relay test kit during upgrading)**

3. Wait until the "Upgrade success" message box pops up.

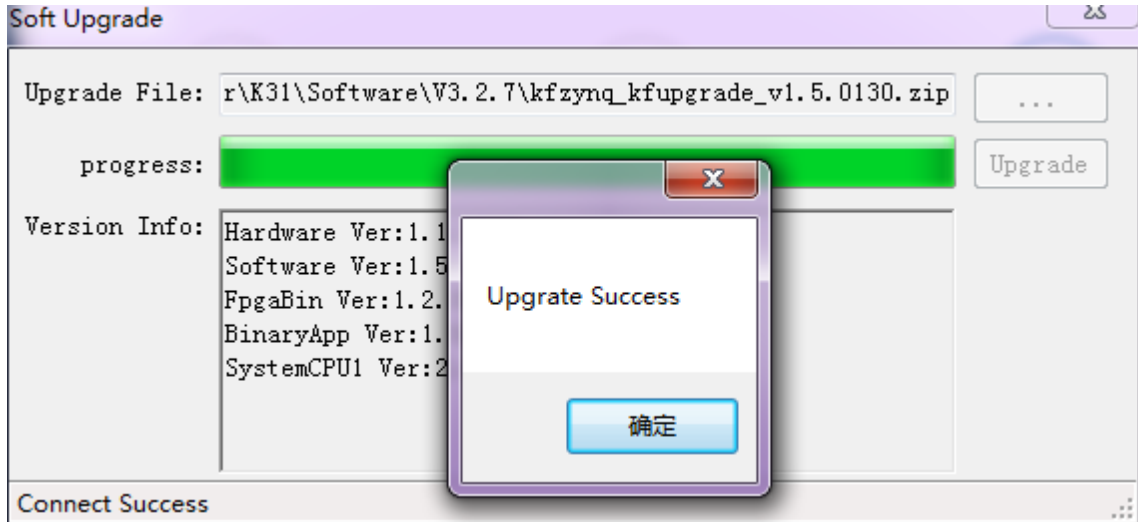

#### 1.2.4.3 License

Display the detail hardware license;

User can update the license with an authorized access code.

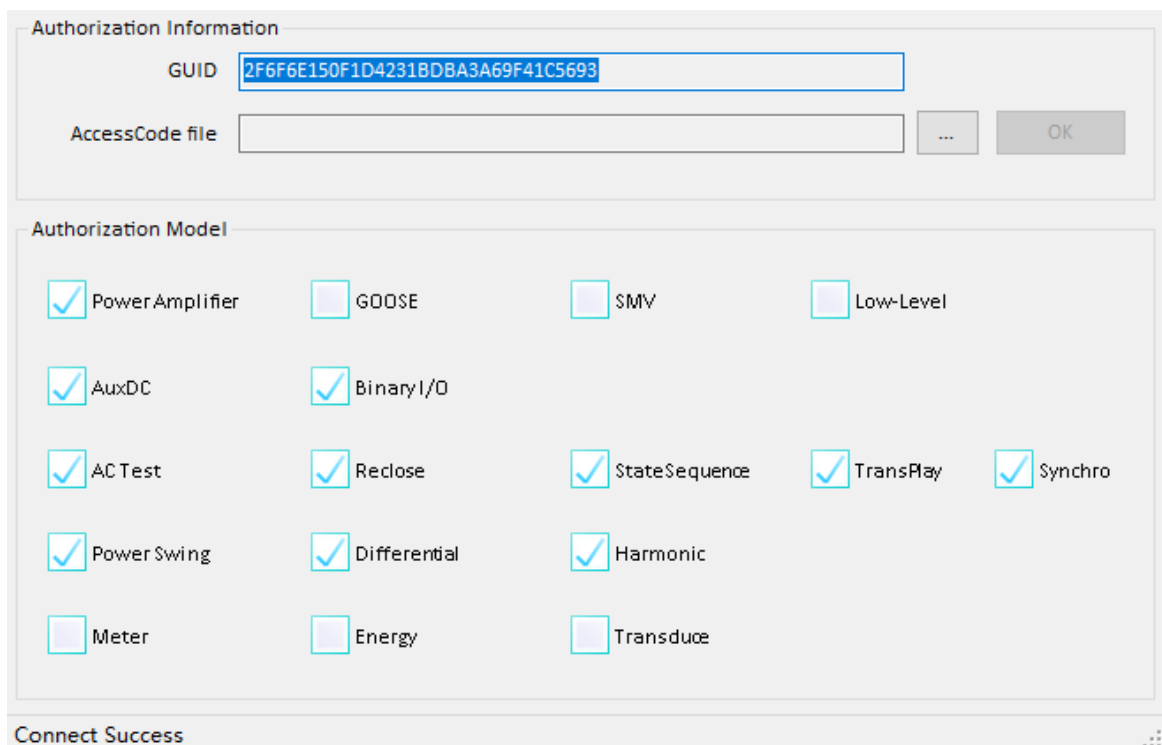



# 1.3 Test Modules Overview

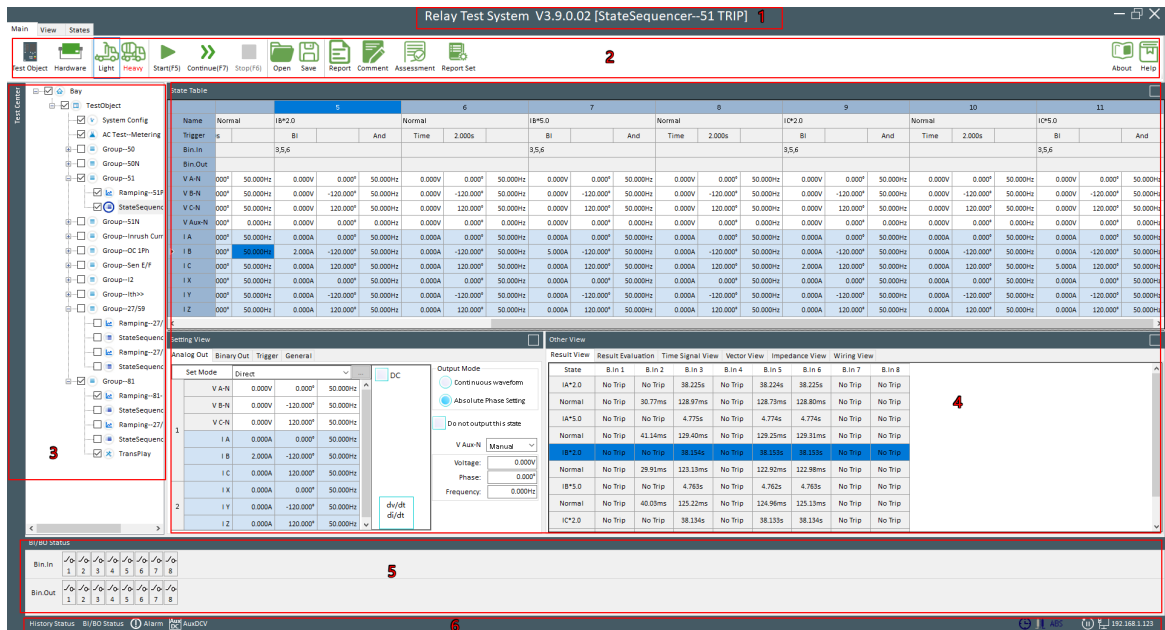

1. Name of selected test module
2. [Menu bar](#)<sup>25</sup>
3. [Test Center](#)<sup>28</sup>
4. [Test view](#)<sup>31</sup>, [Other View](#)<sup>32</sup>
5. Hideable dock panel of "History Status", "BI/BO Status" and "Alarm"
6. Status bar.















## 1.3.1 Menu bar



Menu bar - Main:





**Main - Test Object**

Provide edit / import / export test objects parameter, test template using these parameters in all test modules. Each template file corresponds to a particular test object. See: [Test Object](#)<sup>39</sup>

 System Config	<b>Main - System Config</b> See: <a href="#">System config</a> <sup>132</sup>
 Goose	<b>Main - Goose / SV</b> For IEC61850 SV and GOOSE abnormal test. These two icon only valid while the corresponding IEC61850 & GOOSE function activated.
 SV	<b>Main - Light / Heavy</b> Switch the output burden. <b>Note:</b> This 2 buttons do not valid for all relay test models.
 Light	<b>Main - LoadData</b> Import comtrade file for transplay. This icon only valid in Transplay module.
 Heavy	<b>Main - Combine</b> Arithmetical operation the data of selected channels and generate for transplay. This icon only valid in Transplay module.
 LoadData	<b>Main - Open</b> Open a XML format test result for review.
 Combine	<b>Main - Save</b> Save test result to a XML format file for review purpose.
 Open	<b>Main - Report</b> Save the test reports in ".RTF" format corresponding to Report Config for edit or print purpose.
 Save	<b>Main - Start(F5) / Stop(F6)</b> Start / Stop buttons control the test procedure by the user.
 Report	<b>Main - Continue (F7)</b> Start the test procedure from currently selected test point of the test module in test center.
 Start(F5) Stop(F6)	<b>Main - Virtual BinIn (F12)</b> Manual simulate the binary input signal by button or F12 keyboard.
 Continue(F7)	<b>Main - Clear Result</b> Clear the test result of current selected module.
 Virtual BinIn(F12)	
 Clear Result	

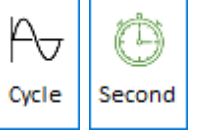

 Comment	<p><b>Main - Comment</b></p> <p>Add a comment to the report for a tested module.</p>
 Assessment	<p><b>Main - Assessment</b></p> <p>Manually assessment the test result for a tested module.</p>
 Report Set	<p><b>Main - Report Set</b></p> <p>User can define the report contents.</p>

Menu bar - View:

 Primary Secondary	<p><b>View - Primary &amp; Secondary</b></p> <p>Toggle change the values displayed for primary or secondary, calculated by the ratio settings.</p>
 Relative Absolute	<p><b>View - Relative &amp; Absolute</b></p> <p>Toggle change as absolute or relative values corresponding the ratio settings.</p>
 Cycle Second	<p><b>View - Second &amp; Cycle</b></p> <p>Toggle change the time of results in second or cycle.</p>

1.3.2 Status bar

History Status	Toggle display the "History Status" dock.																																				
BI/BO Status	Toggle display the "BI/BO status" dock. <table border="1" data-bbox="574 1523 1061 1691" style="margin-left: 20px;"> <tr> <td>Bin.In</td> <td></td><td></td><td></td><td></td><td></td><td></td><td></td><td></td> </tr> <tr> <td></td> <td>1</td><td>2</td><td>3</td><td>4</td><td>5</td><td>6</td><td>7</td><td>8</td> </tr> <tr> <td>Bin.Out</td> <td></td><td></td><td></td><td></td><td></td><td></td><td></td><td></td> </tr> <tr> <td></td> <td>1</td><td>2</td><td>3</td><td>4</td><td>5</td><td>6</td><td>7</td><td>8</td> </tr> </table>	Bin.In										1	2	3	4	5	6	7	8	Bin.Out										1	2	3	4	5	6	7	8
Bin.In																																					
	1	2	3	4	5	6	7	8																													
Bin.Out																																					
	1	2	3	4	5	6	7	8																													
Alarm	Toggle display the "Alarm" dock. While an alarm occurred, the color of "Alarm" text will be in RED, and the alarm signal indicator also in RED. <table border="1" data-bbox="574 1848 1284 1937" style="margin-left: 20px;"> <tr> <td></td><td></td><td></td><td></td><td></td><td></td><td></td><td></td><td></td><td></td><td></td><td></td> </tr> <tr> <td>V,H</td><td>V,I</td><td>V,S</td><td>I,H</td><td>P,B</td><td>L,I</td><td>I,A</td><td>I,B</td><td>I,C</td><td>I,X</td><td>I,Y</td><td>I,Z</td> </tr> </table> <table border="1" data-bbox="574 1971 1284 2027" style="margin-left: 20px;"> <tr> <td>V,H</td> <td>Voltage Amplifier overheating</td> </tr> </table>													V,H	V,I	V,S	I,H	P,B	L,I	I,A	I,B	I,C	I,X	I,Y	I,Z	V,H	Voltage Amplifier overheating										
V,H	V,I	V,S	I,H	P,B	L,I	I,A	I,B	I,C	I,X	I,Y	I,Z																										
V,H	Voltage Amplifier overheating																																				

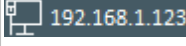
	V,I	Voltage Amplifier wrong connected to external H.V source
	V,S	Voltage output wiring shorted
	I,H	Current Amplifier is overheating
	P,B	Main +/- power supply in imbalance
	L,I	Low-level outputs wrong connected to external H.V source
	IA,IB,IC,IX,IY,IZ	Correspond current outputs wiring opened.
AuxDCV		Active/Deactive Auxiliary DC output, see <a href="#">AuxDC</a> <sup>22</sup>
		Indicate the running / stop status.
		Disconnect status
	192.168.1.123	Connected to the corresponding IP address.

### 1.3.3 Test Center

Test center organizing all the system config and test modules as a tree-node view, it performing the testing process from top to bottom and parent node to child node; User can right-click mouse to operate on the tree-node;

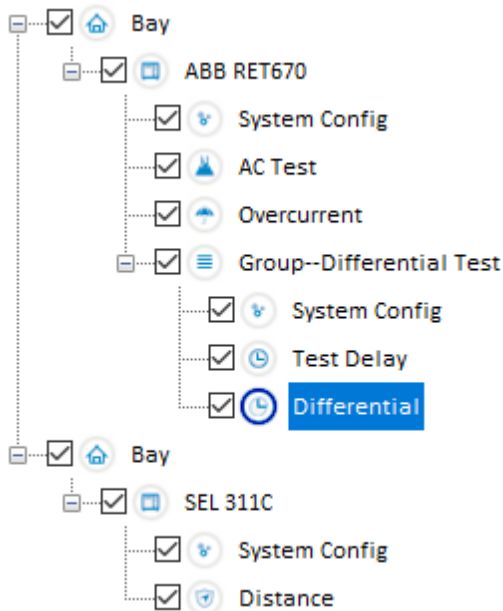

- 1 The top level node is "Bay"; In test center may have multi-bay to organize the test objects according the real scenario.
- 2 The second level node is "Test Object"; Under a bay may have multi-objects, **A testing process is only performed within the scope of one test object, not across it anyway.**
- 3 Below the "Test Object" is "System Config" and other user defined test modules; Each module can active / deactive, the test process

only performing the activated modules.

### Functions:

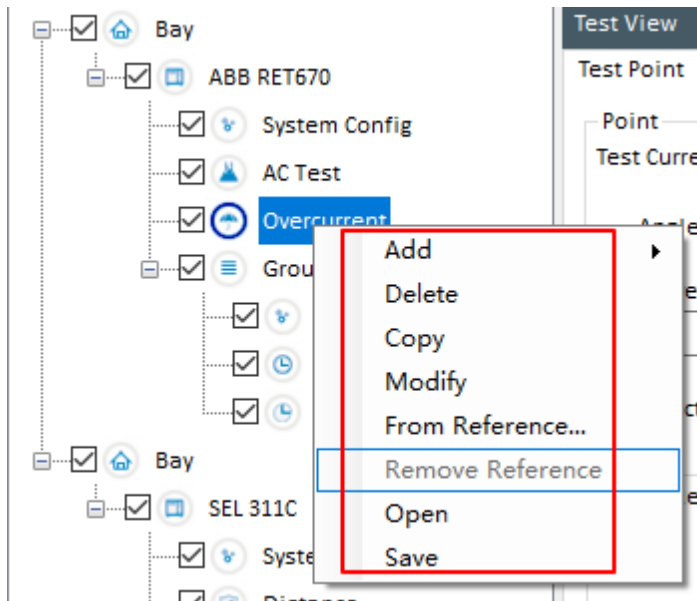

Add	Add a test module after current selected node.
Delete	Delete current selected node.
Copy	Append a selected node at the last.
Modify	Rename or change the settings of current selected node.
From Reference..	Link a binary reference parameter from the data of test object. This data will binding and active/deactive to current node. A linked node will appear as blue ground color and disable user operate the active/deactive selection until remove the link reference.
Remove Reference	Remove the linked reference.
Open	Open an exist template.
Save	Save the present settings to a template file.

## Special nodes:

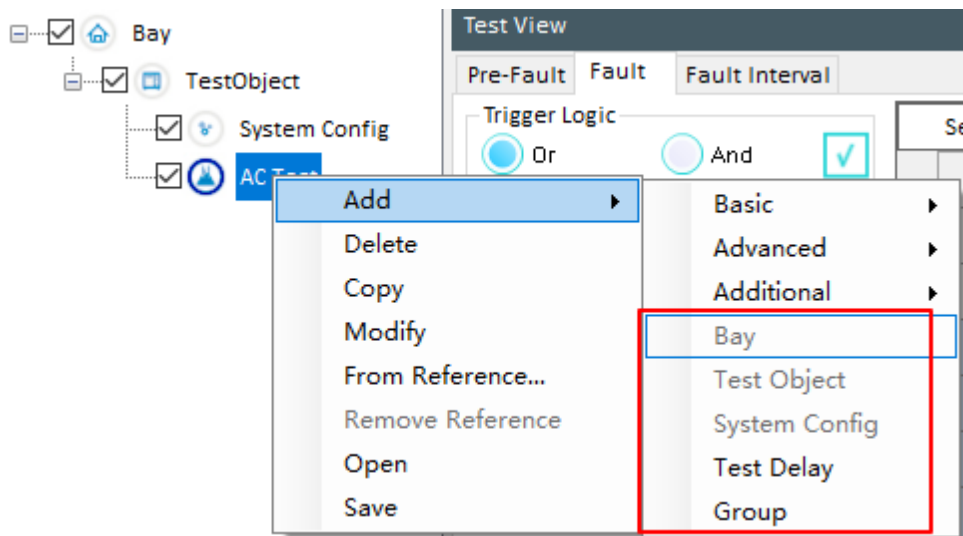

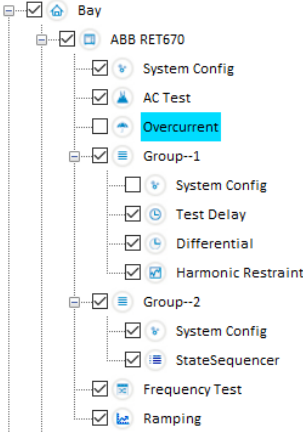
Bay	<b>Bay</b> is the top level node; In test center may have multi-bay to organize the test objects according the real scenario.
Test Object	<b>Test Object</b> is the second level node; Under a bay may have multi-objects, <b>A testing process is only performed within the scope of one test object</b> , not across it anyway. All test modules must under a test object.
System Config	System Config saved all the settings relation to the testing kit; It is a kind of test module. Under a test object, may have multi-System Configs, each system config only effective for the after modules and child-nodes, it will not effective to the previous modules or super-node. Each test module will search a nearest previous or super-node system config to use.
	 <p>Example:</p> <ul style="list-style-type: none"> <li>• There have 3 system configs: S1, S2 and S3;</li> <li>• S1 is the default system config, it valid in the full range of this test object, it is not able to delete and can not be deactivated.</li> <li>• The valid range of S2 is under Group-1 and its child-node while it is activated.</li> <li>• The valid range of S3 is under Group-2 and its child-node while it is activated.</li> </ul> <p>In this example:</p> <ul style="list-style-type: none"> <li>• Because S2 is deactivated, so only StateSequencer using S3; Others modules all using S1;</li> <li>• If S2 toggle to activated, then Test Delay, Differential and Harmonic</li> </ul>

	<p>Restraint will switch to use S2, StateSequencer remaining use S3, others modules using S1;</p> <ul style="list-style-type: none"> <li>• If S3 toggle to deactivated, then all modules will use S1 as the system config.</li> <li>• If S2 toggle to activated and S3 toggle to deactivated, Test Delay, Differential and Harmonic Restraint will switch to use S2, others modules include StateSequencer will use S1;</li> <li>• The Overcurrent module linked to reference data, user can not manually change the active/deactive status.</li> </ul>
Test Delay	It is a kind of test module; Allow user pause the testing process, and display an user-defined prompt message and picture.
Group	It is a parent tree-node for organize the child test modules. A group can contain other child-groups.

### 1.3.4 Test view, State Table view, Setting view

Test view, State Table view and Setting view are the main parameters panel of each test module.

State Table view valid in StateSequencer module only.

Setting view valid in Frequency test module only

### 1.3.5 Vector View

According the function of testing module, Display the voltage and current outputs in text and graphic mode.

User can change the display in PToP, PToE, Symmetrical, Power modes;

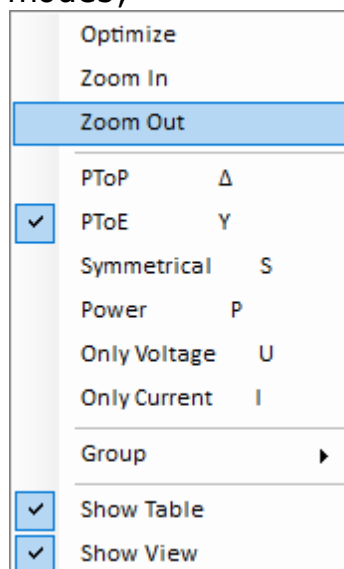

### 1.3.6 Other View

Other View have multi-tabs, corresponds to the test modules. The tabs include Result view, Wiring view, Time signal view, Impedance view, Overcurrent Characteristic view, Differential characteristic view, etc.

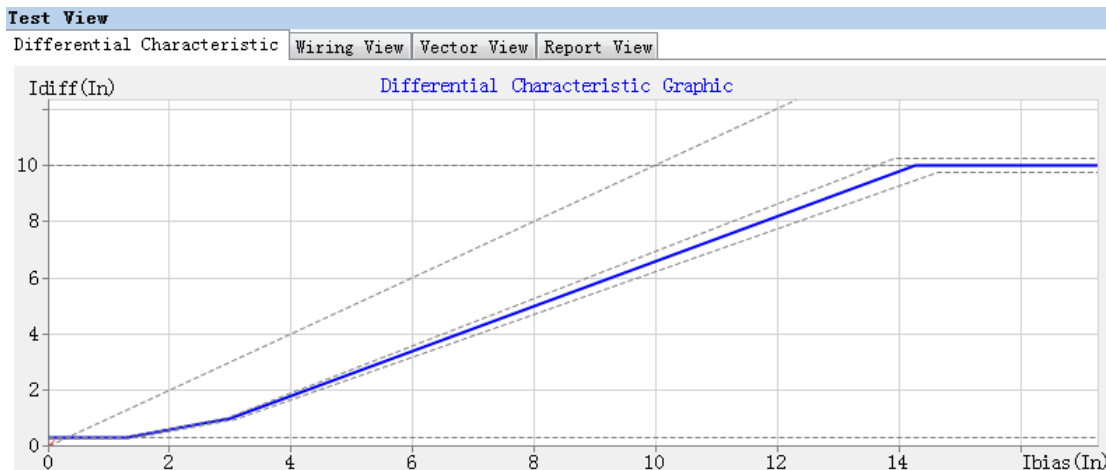
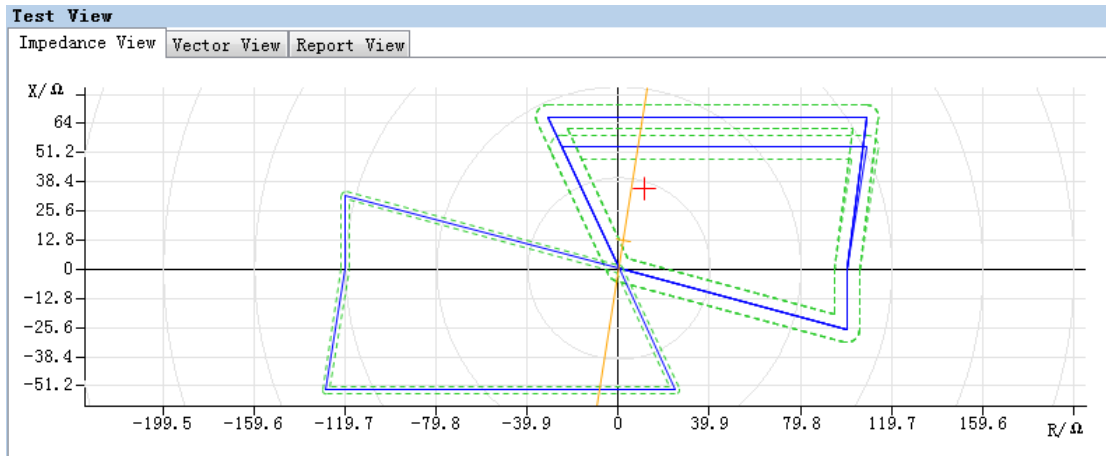

## 1.4 System config

Selecting "System Config" from Main menu can enter into system configuration.

Allow user to define the relay test kit working mode, include:

Output type	Power Amplifier
	Low-Level
	IEC-61850-9-2
	IEC-61850-9-1
	FT3
Binary Type	Collector
	Hard (Dry / Wet inputs & relay type outputs)
	Goose
	Virtual Binary Input (Manual simulate binary input signal); See <a href="#">Binary</a> <sup>20</sup> , <a href="#">Menu</a>



Ratio Config	bar <sup>D26</sup> Group1 - Group6
Current Open Circuit Alarm Detection	A threshold value setting for open circuit detection sensitivity. Below this setting value will not activate the open circuit determine function. Range: 0.01A ~ 0.05A; default setting: 0.02A This setting is valid for Power Amplifier mode only.
IEC61850 Ed 2.0	While IEC61850 selected, user can choose the edition version in Ed1.0 or Ed2.0;

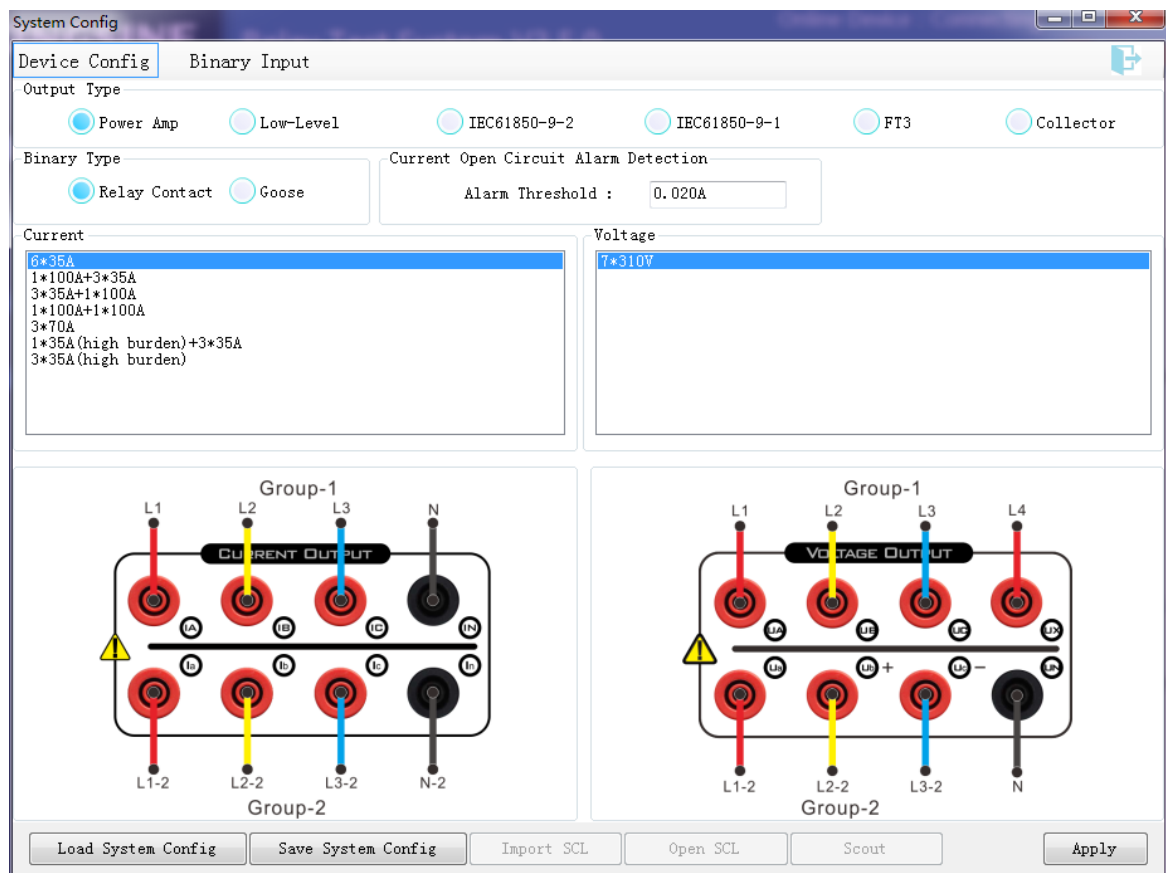

After finishing the configuration, must press "Apply" to submit the setting. If test kit is not online, "Send Config Failed" message will pop up.

### 1.4.1 Device Config

#### Device Config

On "Device Config" tab of System Configuration allow set the test kit output mode as Analog amplifier output ,Low-Level outputs, IEC61850 mode

Output Type

Pow Amp  
  Low-Level  
  IEC61850-9-2  
  IEC61850-9-1  
  FT3  
  Collector

Output Type	
Amplifier mode	Define the voltages and currents outputs from the amplifier channels. Amplifier output mode have to selection. See: <a href="#">Amplifier output connection</a> <sup>35</sup>
Low-Level output mode	Define the voltages and currents outputs from the Low-Level output ports.
IEC61850 modes	This modes include IEC61850-9-1, IEC61850-9-2, FT3, Collector. Its defined the voltages and currents outputs by the mapping of SV channels of IEC61850 protocol.

Binary Type

Hard  
  Goose

Binary Type	
Hard	Define the Binary I/Os from the hard type I/O ports (Banana or Combination ports).
Goose	Define the Binary I/Os by the mapping GOOSE channels (Fiber ports)

### Ratio config

#### Ratio for Low-Level output mode:

Ratio Config

Group 1 | Group 2 |

	Input (11v)	Output (11v)
V A-N	300.000V	8000.000mV
V B-N	300.000V	8000.000mV
V C-N	300.000V	8000.000mV
I A	200.000A	8000.000mV
I B	200.000A	8000.000mV
I C	200.000A	8000.000mV
V X-N	300.000V	8000.000mV

#### Ratio for IEC61850 mode:

Ratio Config

Group 1 | Group 2 | Group 3 | Group 4 | Group 5 | Group 6 |

	Primary	Secondary	Reference (9-2)	Sample (9-2)
V A-N	110.000kV	100.000V	10.000mV	1
V B-N	110.000kV	100.000V	10.000mV	1
V C-N	110.000kV	100.000V	10.000mV	1
I A	100.000A	1.000A	1.000mA	1
I B	100.000A	1.000A	1.000mA	1
I C	100.000A	1.000A	1.000mA	1
V X-N	110.000kV	100.000V	10.000mV	1

"Ratio config" defined the ratios used for Low Level output and IEC61850 modes.

Low Level output modes effective only Group1 and Group2, IEC61850 mode can effective up to 6 groups.

Ratio of Power Amplifier mode doesn't defined here, It is defined in

the [Device object](#) <sup>42</sup>

## 1.4.2 Amplifier output connection

Amplifier output modes is automatic detected by the analog channels of currently hardware configurations.

### Configurable of Current Channel

#### For 6-phase currents model

	<p>6-Phase independent channel output.</p>
	<p>3-phase group1 &amp; group2 parallel output mode.</p>
	<p>3-phase + 1-phase group1 set as independent output, group2 set as 3-phase parallel mode.</p>
	<p>1-phase + 3-phase group1 set as 3-phase parallel mode, group2 set as independent output. this mode only available for few modules, like AC test, Ramping, State sequence.</p>
	<p>1-phase + 1-phase group1 &amp; group2 set as 3-phase parallel mode. this mode only available for few modules, like AC test, Ramping, State sequence.</p>
	<p>3-phase DC current output mode output from group1 ports, short group2 ports to neutral.</p>

## For 3-phase currents model

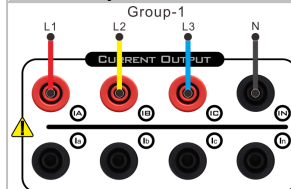

3-Phase

independent channel output.

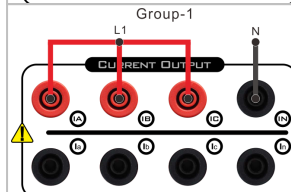

1-phase

group1 set as 3-phase parallel mode

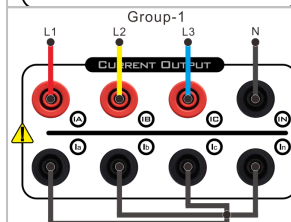

3-phase DC current output mode

output from group1 ports, short group2 ports to neutral.

## Configurable of voltage channels

## For 4-phase voltages model

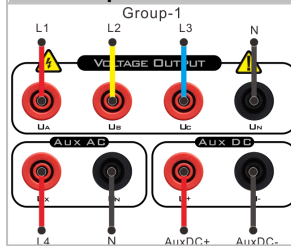

4-phase voltages with/without Auxiliary DC output

## For 7-phase voltages model

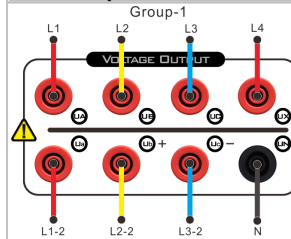

7-phase voltages independent output mode without Auxiliary DC output.

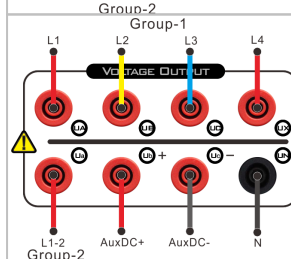

5-phase voltages independent output with Auxiliary output mode.

while activated Auxiliary DC output, the Ib and Ic channel of group2 will automatically disabled.

## 1.4.3 IEC61850 mode

The Top Menu will automatic active according the selection of **IEC61850-9-1 / IEC61850-9-2 / FT3 / Collector** modes.



See: [IEC61850-9-1 / 2](#)<sup>37</sup>

### 1.4.3.1 IEC61850-9-1 / 2

IEC61850-9-1 / IEC61850-9-2 is different protocol type of IEC61850. user should set to correct mode according the actual IED device.

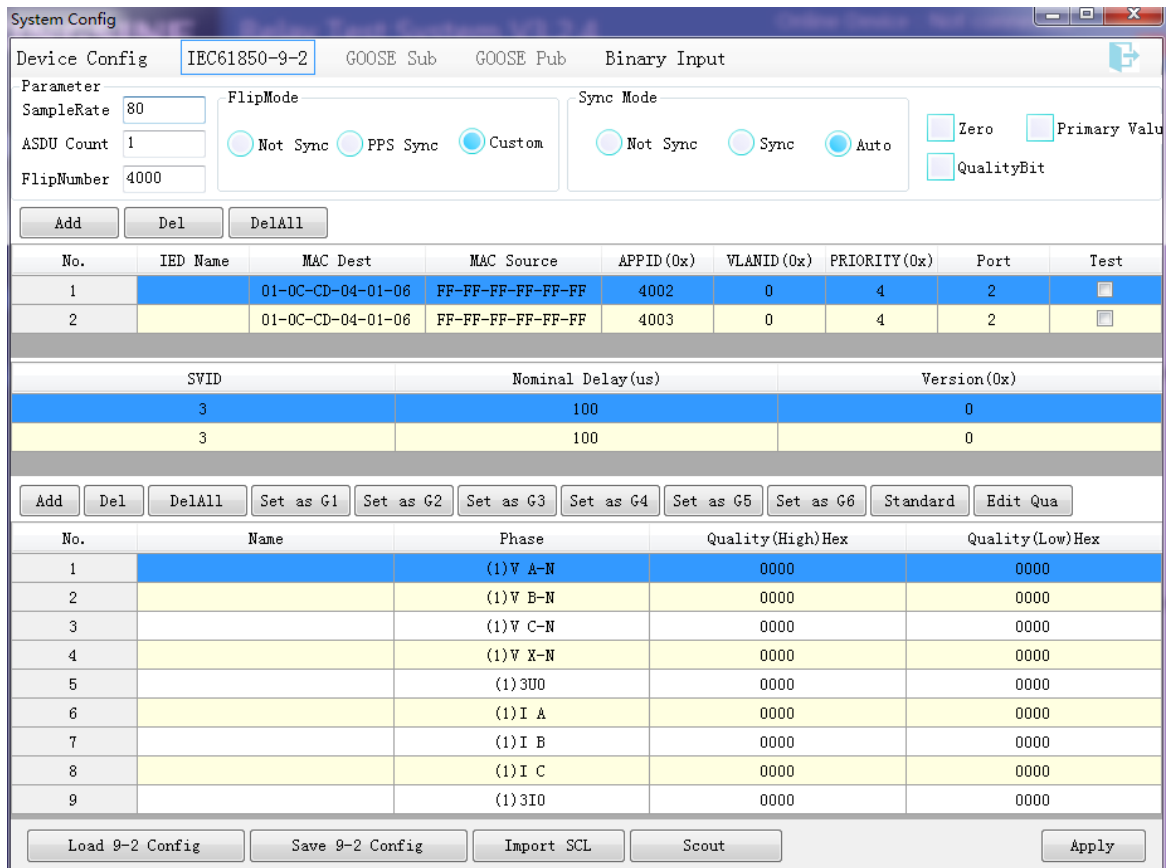

User can import from a defined SCD/CID/ICD file or load from a saved file to quickly start the configurations. The "Scout" button provide an online SV detection.

IED selection:

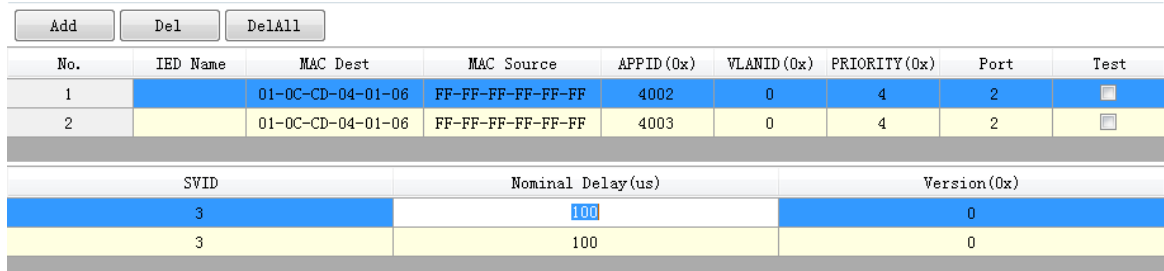

This area allow to select connected IED device.

Fiber channels mapping:

No.	Name	Phase	Quality(High)Hex	Quality(Low)Hex
1		(1)V A-N	0000	0000
2		(1)V B-N	0000	0000
3		(1)V C-N	0000	0000
4		(1)V X-N	0000	0000
5		(1)3U0	0000	0000
6		(1)I A	0000	0000
7		(1)I B	0000	0000
8		(1)I C	0000	0000
9		(1)3I0	0000	0000

This area allow edit and mapping the SV channels to a logic channel which displayed on all the test modules.

"Set as G1-6" are the shortcut button map to Group1 - Group 6.

### 1.4.4 Binary input & outputs

#### 1.4.4.1 GOOSE mode

GOOSE Subscription & GOOSE Publish will active according the "GOOSE" of "Binary Type" selected.

User can import from a defined SCD/CID/ICD file or load from a saved file to quickly start the configurations.

The "Scout" button provide an online GOOSE event detection.

GOOSE map to Binary inputs:

No.	Description	Type	Value/Sub Length	MapBinary	MapBit	Address
1		Boolean	<input type="checkbox"/>	Binary In1	/	
2		Boolean	<input type="checkbox"/>	Binary In2	/	

User should select the correct GOOSE channel map to binary inputs.

#### 1.4.4.2 Hard Contacts (Relay type)

"Binary input" allow user define the type of binary input signal.

Input	Contact Type	Trigger Type	Nominal Voltage
1	Potential free	Low Level	15.000V
2	Potential free	Low Level	15.000V
3	Potential free	Low Level	15.000V
4	Potential free	Low Level	15.000V
5	Potential free	Low Level	15.000V
6	Potential free	Low Level	15.000V
7	Potential free	Low Level	15.000V
8	Potential free	Low Level	15.000V

The turnover conditions of each binary inputs must fulfilled the [Deglitch time](#)<sup>43</sup>.

#### Columns and substantive description

Input	Binary input ports
Contact type	1. Dry contact 2. Trigger on threshold
Trigger type	Low Level or High Level, available for "Trigger on threshold" type.
Nominal voltage	Set the DC trigger Nominal voltage in "V", available for "Trigger on threshold" type.
Reaction's threshold (%)	Factor of trigger threshold voltage, allow user control the trigger threshold accuracy.

## 1.5 Test Object

Selecting "Test Object" from Main menu can enter into Test Object configuration.

In KRT software, Test Object parameter was built in the test template(.KRT)

More information, See: [Basic Concept](#)<sup>8</sup>

#### Test Object View:

From the Menu "Parameter " or Toolbar, selecting "Test Object" can enter the Test Object view.

On the left section displays the test objects management: user can add or delete objects and change currently active object from the list. It also provides the "Edit" entry for relay parameter import and filter functions ([Test Object Converter](#)<sup>41</sup>).

On the right side displays all the parameters for Device, Distance, Overcurrent, Differential, Synchronize, Circuit Breaker, .etc functions. All parameters on the right side are imported from the TOS filter. Any changes in this Test Object view will not reverse map to TOS filter. Anyhow, all parameters in this window are the only effective parameters of test object during testing.

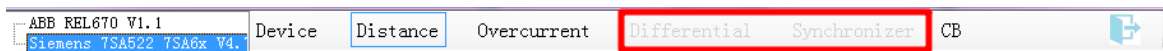

The light gray font on the top tab bar means this function has not been defined in the present active object on the left side. Parameters under this function was set to a default parameters.

#### Buttons of Test Object:

Rename	Rename the selected test object.
Delete	Delete the selected test object.
Import (.RIO/.RIO3)	Import a .RIO/.RIO3 format file to Over Write current test object settings; or Export present active test object settings to a .RIO/.RIO3 format file; .RIO format is used compatibility for KRT Version
Export (.RIO/.RIO3)	



	2.x and 3.x; but not all features able to export to .RIO format file such as more than 3 elements in each Overcurrent element type. .RIO3 format only compatibility for KRT V3.x;
Edit / Import .Krt Template	Entry to Test Object Converter will enable editing of the a .Krt template, import settings from relay parameters, etc.
Save	Save modified settings. All changes in this window are only effective after saving, otherwise they will be abort after exiting this window.
Save & Exit	Save modified settings and exit to test center.

### 1.5.1 Test Object Converter

Press "EDIT" button from the "Test Object" on the left manager panel to enter into the Test Object Converter.

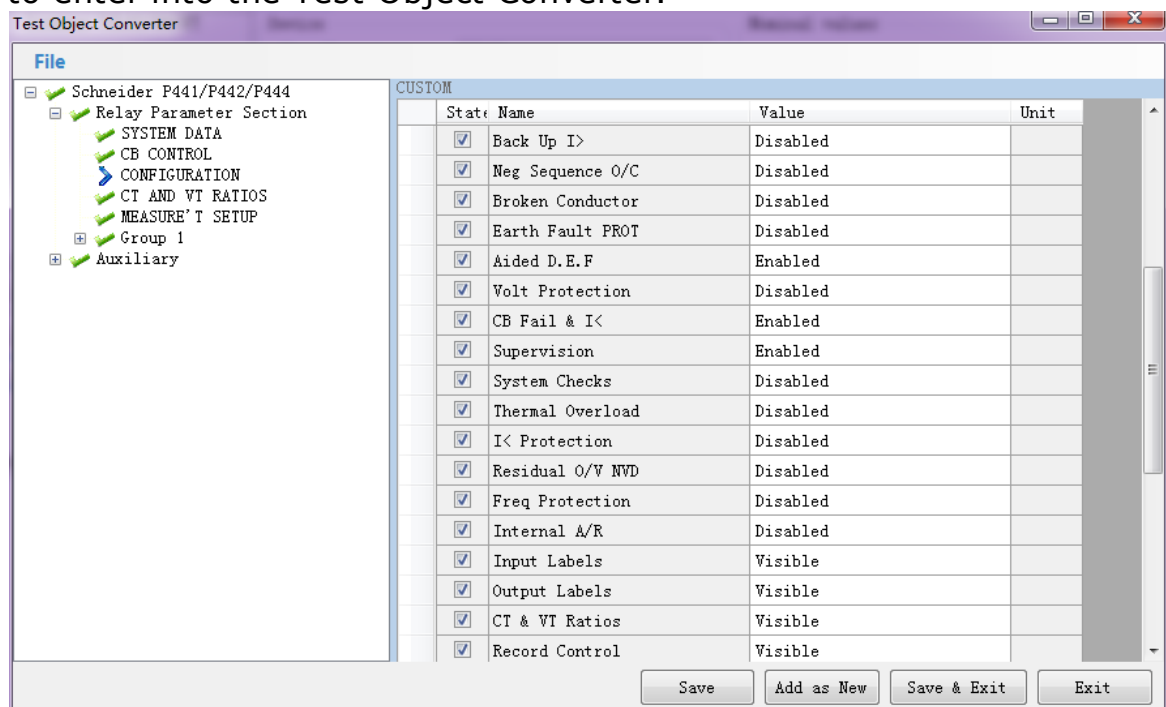

The Test Object Converter uses a TOS filter to display the relay data. It is constructed similarly to the relay manufacturers for which includes all the data of the relay under testing. TOS filter allows the user to manually enter the parameters or use **import** function to copy the relay data from relay parameter setting software. It will automatically convert the relay data to the KRT test parameters.

3 steps to achieve the converted parameters:

1. Open a .KRT template according to the current relay under testing and enter into the test object converter interface by "Test object" - > "Edit".
2. Enter parameters manually or use the "import" function to import from relay data to the TOS filter fields.

3. Confirm and Save to the KRT test object.

### Import Function

A .KRT template file may has inbuilt multiple different filters allowed for selection.

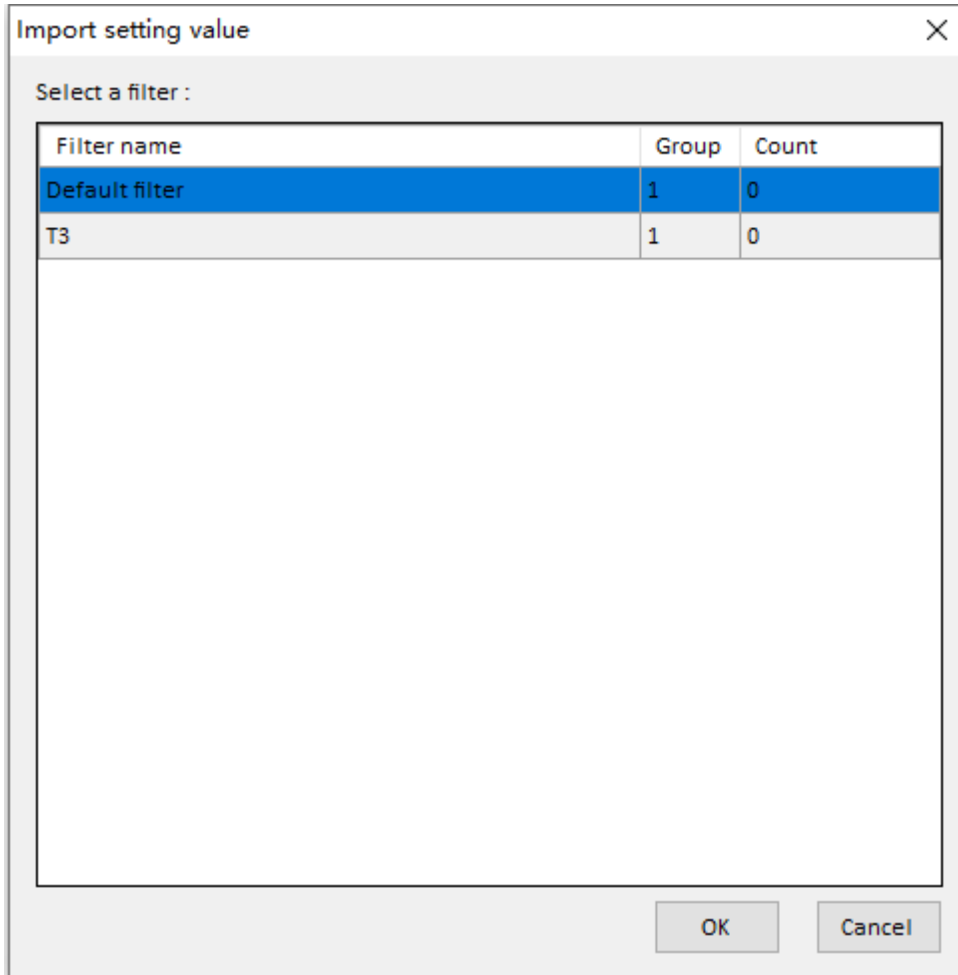

### Buttons of Test Object Converter:

Save	Overwrite current settings on selected test object in Test Center.
Add as New	Add as new test object to Test Center.
Save & Exit	Overwrite current settings on selected test object in Test Center & Exit.
Exit	Exit to test object view.

## 1.5.2 Device object

### Device tab description:

Device/ Substation/Bay	Test object's information.
Nominal values	Number of Phases f nom: Nominal frequency

	<p>V nom(L-L): L-L voltage of the PT in primary or secondary side.</p> <p>V nom(L-N): L-N voltage of the PT in primary or secondary side.</p> <p>I nom: I nominal of CT in primary or secondary side. Primary and secondary CT / PT parameters, these settings effective the ratio on <a href="#">relative</a><sup>□25</sup> display. (for IEC61850 &amp; Low-Level modes, the ratio see "<a href="#">Device config</a>"<sup>□33</sup>).</p>
Deglitch time	Filter the instantaneous impulse trig signal, programmable from 0~25ms

### 1.5.3 Distance Object

PT location:

at line:	Voltage of Post-fault = 0V
at busbar:	Voltage of Post-fault = Vnom

CT starpoint:

Dir. line:	the injected current flows from the test kit into the test object.
Dir. busbar:	the injected current flows from the test object into the test kit.(180° phase shift)

Grounding Factor:

The grounding factor is applicable for single phase ground faults impedance measured in response to the relay.

ZL grounding factor is used for constant current or constant voltage fault mode.

ZS grounding factor is used for constant system impedance mode. ZS impedance settings see: [Test Parameter](#)<sup>□86</sup> of distance module.

3 modes to help input these parameters from the relay settings. For ZL grounding factor input: **KL, RE/RL & XE/XL, Z<sub>0</sub>/Z<sub>1</sub>**

**KL** uses Magnitude and Angle mode to calculate:

$$KL = \frac{Z_0 - Z_1}{3 * Z_1} = \text{Re}(KL) + j \text{Im}(KL) = |KL| \angle \theta$$

**RE/RL & XE/XL** use resistance and reactance mode to calculate:

$$\frac{RE}{RL} = \frac{R_{Z0} - R_{Z1}}{3 * R_{Z1}} = KR \quad \& \quad \frac{XE}{XL} = \frac{X_{Z0} - X_{Z1}}{3 * X_{Z1}} = KX$$

*Note: KR & KX does not represent the real and imaginary parts of the grounding compensation coefficient K, and the conversion from KR & KX to K as below:*

$$K = \frac{K_R R_{Z1}^2 + K_X X_{Z1}^2}{R_{Z1}^2 + X_{Z1}^2}$$

$Z_0/Z_1$  is polar coordinate that represents the magnitude and angle of KL.

"Z0" represents the zero-sequence impedance while "Z1" represents the positive-sequence impedance of the line protected.

For ZS grounding factor input: **KM, RE/RL & XE/XL, Z<sub>0M</sub>/Z<sub>1M</sub>**

ZS grounding factor is the equivalent line impedance (positive sequence impedance) of the system power supply to the location of protected object, it is only valid when the fault model is set as "Zs constant"; all formula representation should be referred to the grounding factor.

#### Tolerances:

Time and Impedance tolerances for the assessment are compared. These are the global tolerance for all impedance zones instead of one that is defined in any particular zone.

Relative and Absolute tolerances will be calculated to figure out the greater value of the two.

#### Zones

The zone list contains a listing of all specified zones for all fault loops.

A graphical editor allows the user to define the nominal relay characteristics and settings easily.

"New", "Remove" and "Edit" buttons enable adding or deleting a zone, as well as modifying the characteristic of the selected zone.

Active	only active zones are in-use when a test is performed.
Zone	the name of individual zone
Label	for individual zone identification.
Type	Tripping: tripping zone has a corresponding trip time associated with it. Extended: extended zone is similar to a tripping zone. The user can define whether an area requires activation while testing. Non-tripping: this zone has no tripping allowed (e.g. load encroachment area)
Fault loop	specifies the fault types for which the settings are valid.
Trip Time	Tripping time for each zone.

### 1.5.4 Overcurrent Object

PT connection:

on line:	Voltage of Post-fault = 0V
on busbar:	Voltage of Post-fault = Vnom

CT starpoint:

Towards line:	Phase shift between the currents and voltages = fault angle.
Towards busbar:	Phase shift between the currents and voltages = fault angle + 180°.

PT and CT connections setting will be disabled while "Directional behavior" of the relay is set as "Non-Directional".

Overcurrent elements

Element type include:

IL	Phase element
IN	Residual element
I1	Positive sequence element
I2	Negative sequence element
I0	Zero sequence element

Element list:

Active	only activated elements are in-use when a test is being performed.
Element name	Unique name for each element; double-click the cell to rename it.
Characteristic	Name of the tripping characteristic.
I pick-up	Pick-up current of the element, specified as a multiple of the Inom.
Time	It gives the trip time in seconds for a definite time characteristics and a time index for inverse characteristics.
Direction	It can be Forward, Reverse or Non-directional

**Note:** All active elements are treated as working in parallel, see "View Resulting Characteristic" for the final combined curve.

Define Element Characteristic

The current characteristic selection controls the display of parameter fields in the "Characteristic" area.

To those self-defined elements, the parameters area are of no use.

The parameters A,B,P,Q,K1 and K2 are used for inverse characteristics equation.

The parameters A,Q,P are used for I<sup>2</sup>T characteristics equation.  
The parameters A,B,C,D and E are used for IAC characteristics equation.

From "New" - "Custom", user can define characteristics in tabular form. This area holds a table of current-time value pair defining the characteristics that are required to edit them. The table entries are sorted in an ascending order according to the values.

Reset Characteristic:

Off	no reset time defined
Definite time	fixed reset time for all shot points.
Inverse time	Automatically calculating the reset time tr(s) in seconds $tr(s) = R * Td$ R: definable constant Td: Time index scaling the time axis of the curve.

#### View Resulting Characteristic

This page displays the combined diagram of all active tripping elements defined for an element type.

### 1.5.5 Differential Object

Differential object parameters are managed globally and can be set identically for all differential test modules:

- [Protection Device Tab](#)<sup>46</sup>
- [Characteristic Definition Tab](#)<sup>49</sup>
- [Harmonic Tab](#)<sup>49</sup>

#### 1.5.5.1 Protection Device Tab

##### Protected Object Type

Defined the type of object you want to protect.

##### Windings

Count	Number of windings
Winding	Select reference winding used for measuring currents and phase angles. When testing the Bias curve differential and harmonic restraint, the fault is placed on this selected side.

For 3 windings, if the selected reference winding is Primary, the other side have to be specifically defined according to its test method. 3 windings are only used for testing a transformer objects. the tertiary column is available only if 3 windings are selected for the Count of windings.

#### Balance coefficient calculation method

Select the calculation method or direct setting for balanced coefficient.

#### System parameters table

Powers	Nominal power per winding.
Voltages	Nominal voltage per winding
Currents	Show the line current calculated from power and voltage ratings.
Primary I	Nominal primary current per winding
Secondary I	Nominal secondary current per winding
CT polarity	Define a direction for the CT start point grounding (towards line or towards protected object)
Vector.Group	Define the vector group of connection of the protected object. possible connection are <ul style="list-style-type: none"> <li>• Y(star connection) or</li> <li>• D(delta connection).</li> </ul>
Starpt.Ground	Set a start point grounding of the corresponding winding. This setting influences the current flow for single-phase faults.
Delta - CT	Set whether there is a delta-connection of the CTs While the corresponding vector group is set to Y type.

#### Reference Current

The absolute value of the measuring currents transformed from a reference winding is different for a vector group adjustment or a zero-sequence elimination. This is due to different ratios  $I_{nom}$  instrument transformer /  $I_{nom}$  transformer for the single windings of the transformer.

Therefore, the parameters chosen to testing the absolute value standardization of the currents varies from either using the **Protected Object Nominal Current** or the **CT Nominal Current** for

winding the power. These parameters are required and differ for each relay manufacturer.

#### Zero Sequence Elimination

Zero sequence elimination is relevant for single phase faults only.

- None: The absolute value recalculation will be performed in the relay. no zero sequence elimination.
- IL - I0 : Line current - zero sequence current
- YD interposing Transformer
- YDY interposing transformer

#### Calculate Model

The calculation of the Ir (Ibias) current is handled differently by the relay manufacturers.

$$(|Ip| + |Is|) / K_1$$

$$(Ip - Is) / K_1$$

$$(|Ip| + |Is| \times K_2) / K_1$$

$$\max(Ip, Is)$$

$$\min(Ip, Is)$$

$$\text{sqr}t(Ip \times Is \times \cos(a))$$

$$(|Ip| + |Is| - |Idiff|) / K1$$

#### Diff Current Settings

Enter these parameters settings according to the manufacturer's data sheets.

#### Diff Time Settings

Enter these parameters settings according to the manufacturer's data sheets.

#### Current Tolerances

Enter these parameters settings according to the manufacturer's data sheets. The larger of the relative and absolute tolerance will be used.

#### Time Tolerances

Enter these parameters settings according to the manufacturer's data sheets. The larger of the relative and absolute tolerance will be used.



### 1.5.5.2 Characteristic Definition Tab

This tab defined the bias characteristic of the test object.

#### Diff Current Settings

Idiff> & Idiff>> values are taken from the **Protection Device** tab, "Diff Current Settings".

#### Buttons

Add	Adds the segment defined by the Ibias & Idiff pairs.
Remove	Deletes the currently selected segment.
Tool...	Auxiliary tools for segments generate.

#### No combined characteristic

If the relay measures Ibias and Idiff phase selectively, then the measurement of one phase has a Idiff/Istab current twice as high as the other two phases may occur for certain test objects, vector groups and zero-sequence eliminations.

In the healthy phases, the relays can filter out the currents with high deviation, so activate the "No combined characteristic" option to disable the use of combined characteristic. This will allow for testing relays to block the trip decision in the healthy phases.

### 1.5.5.3 Harmonic Tab

This tab defines the harmonics curves and Tolerances band of the test object.

#### Buttons

Add	Adds the inflection segment defined by the Ixf/Idiff & Idiff pairs.
Remove	Deletes the currently selected segment.

### 1.5.6 Synchronizer Object

#### System 1 (Vs side)

This side simulates the power grid. It will be the reference for synchronization conditions.

Rotation Sense: Set the Vs direction of the Vs side phase rotation

#### System 2 (Vg side)

This side simulates the generator side. It will be synchronized to the Vs side.

Rotation Sense: Set the direction of the Vg side phase rotation

"Use Vs side voltage", enable this option to set the Vg side voltage to be the

same as Vs side. Otherwise, set it as the user defined value.

#### Setting

CB closing time	Displays the CB closing time as set in the CB tab of test object.
Transformer group phase shift	This value is defined from an optional block or coupling transformer.

#### Synchronizer Characteristic

Voltage tolerances & $\Delta v$	Defined the maximum over-voltage( $\Delta v >$ ) and under-voltage( $\Delta v <$ ) with their tolerances. The larger of the relative and absolute tolerance will be used.
Frequency tolerances & $\Delta f$	Defined the maximum above synchronous( $\Delta f >$ ) and subsynchronous( $\Delta f <$ ) with their tolerances. The larger of the relative and absolute tolerance will be used.
Phase tolerances and Phase	Defined the phase shifts and their tolerances between the Vs and Vg side in consideration with CB closure delays and coupling transformer. The larger of the relative and absolute tolerance will be used.
Dead Zones ( $\square f_{min}$ & $\square f_{max}$ )	The Dead Zones are areas when the synchronizing relay should not output any adjustment voltage and frequency control command

### 1.5.7 Circuit Breaker Object

The Circuit Breaker Object configures the CB trip and closes the command delay time while simulates the real connection from CB auxiliary contacting 52a and 52b during trip and closing.

## 1.6 AC test

AC test module provide the basic function, allow the user to manually or automatically output voltages, currents and frequencies statically or as ramped outputs.





#### Prerequisites for testing

It is not necessary to set the [Test Object](#)<sup>39</sup> prior to testing, but this setting will be helpful in the testing.

Define the hardware, routing, wiring and trip commands.

Define the Set mode, Variable, Test mode, Prefault, Fault Interval, etc in the "Test View" of main panel.

## Buttons and Options

	In manual mode, increase the value of current variables; In automatic mode, start fault simulation in positive direction by step value. If step value > 0, then the limit value must > current variable setting; else while step value < 0, the limit value must < current variable setting. Keyboard shortcut is "F2"
	The function is opposite to the  button. Keyboard shortcut is "F3"
	Lock the current output value, allow adjustment of the analog value to your desired, then release this button for a transient signal. This button is only available in manual mode.
<input checked="" type="checkbox"/> Auto Step	Enable this option will shift to auto-ramping mode.
<input checked="" type="checkbox"/> Stop on trigger	Enable this option for automatically stop outputting once the Result Trigger Logic is received.
<input checked="" type="checkbox"/> Pickup & Drop	Enable this option for test the pickup & drop off function automatically at one time. Note: This option will disable the <b>Prefault</b> and <b>Fault Interval</b> state.

## Prefault &amp; Fault Interval

Prefault & Fault Interval are available only when "Auto Step" is activated

<input checked="" type="checkbox"/> Prefault	Enable this option to activate the prefault state in auto-ramping mode. The prefault output value allows custom settings, usually $V=V_{nom}$ , $I=0.0A$ ;
<input checked="" type="checkbox"/> Output once only	Enable this option will limit the prefault output state effective only in the first run time.
<input type="radio"/> Time	Define the output time for prefault state.
<input type="radio"/> Binary + Time	Prefault state will switch to fault state by a Binary inputs command or once the time was met.
<input type="radio"/> Key-Press	Prefault state will switch to fault state by a keyboard command.
<input checked="" type="checkbox"/> Fault Interval	Enable this option to add a state after the fault state. The time and value of fault interval allows custom settings, usually $V=0.0V$ , $I=0.0A$ ; Enable this option will shift to the pulse ramping mode.

### Variable setting

Provide variable selection, it can be any channel(s) and any quantity of amplitude, phase angle or frequency.

### Fault state output mode

<input checked="" type="radio"/> Continuous waveform	Set the output phase angle as continuous waveform while state changing.
<input type="radio"/> Absolute Phase Setting	Set the output phase angle as absolute setting while state changing.

### U Aux-N config

Set the U Aux-N channel output during the shot testing.

Manual	This mode allows the user to manually define the U Aux-N output.
+U0, -U0, + $\sqrt{3}$ *U0,- $\sqrt{3}$ *U0 +3U0,-3U0, + $\sqrt{3}$ *3U0,- $\sqrt{3}$ *3U0	These modes will automatically calculate the U Aux-N output from the vector sum of 3-phase network.

## 1.6.1 Set Mode of Analog Output

Analog outputs provides 11 set modes for 3-Phase network.

1. Direct	Set Line-Neutral values.
2. Line-Line	Symmetrical, allow set line-line voltage, V0, phase currents and angles, All the frequency value is received from the Fnom of Device tab in Test Object.
3. Symmetrical	Provide the settings for V1, V2, V0, I1, I2, I0 and angles.
4. Powers	Provide the settings for real power(W), reactive power(var), phase voltages and angles.
5. Fault value	Provide the settings for fault type, voltage, current and angle.
6. Z-I Const	Provide the settings for the fault type, fault impedance and test current. the fault voltage calculated by module. If the fault voltage greater than Vnom*0.9, module will automatically reduce the test current.
7. Z-V Const	Provide the settings for the fault type, fault impedance and test voltage. The fault current is calculated by the module. If the fault current is greater than Imax output, the module will automatically reduce the test voltage.
8. Z-Zs Const	Provide the settings for the fault type, fault impedance and SIR, the fault current and voltage is

	calculated by the module. $ZS = ZL * SIR$ , $ZL$ is line impedance, by default, the grounding factor of $ZS$ equal to $ZL$ 's grounding factor.
9. Z%-I Const	Provide the settings for the fault type, fault impedance in % of selected relative zone impedance, and the test current, the fault voltage is calculated by the module. If the fault voltage is greater than $V_{nom} * 0.9$ , the module will automatically reduce the test current.
10. Z%-V Const	Provide the settings for the fault type, fault impedance in % of selected relative zone impedance, and the test voltage, the fault current is calculated by the module. If the fault current is greater than $I_{max}$ output, the module will automatically reduce the test voltage.
11. Z%-Zs Const	Provide the settings for the fault type, fault impedance in % of selected relative zone impedance and $SIR$ , $ZS = ZL * SIR$ , $ZL$ is line impedance, by default, the grounding factor of $ZS$ equal to $ZL$ 's grounding factor.

When selecting the test mode as Z-I, Z-V, Z-Zs, Z%-I, Z%-V, Z%-Zs Const modes, the user can pickup a test impedance from the impedance view with mouse click to get the test point.

The grounding factor and test line length will use the "[Distance Object](#)"<sup>43</sup> Test Object" to define the parameters.

## 1.6.2 Ramping mode

Ramping modes is different according to whether the mode is active during the "Prefault" and "Interval time" period.

Prefault & Fault Interval	Disabled "Output once only"	Enabled "Output once only"
Normal ramping mode: <input type="checkbox"/> Prefault <input type="checkbox"/> Fault Interval		n/a
Ramping with Prefault: <input checked="" type="checkbox"/> Prefault <input type="checkbox"/> Fault Interval		
Ramping with Fault Interval: <input type="checkbox"/> Prefault <input checked="" type="checkbox"/> Fault Interval		n/a

Ramping with Prefault and Fault Interval:

Prefault

Fault Interval

### 1.6.3 Fault Trigger Logic

Result Trigger Logic

Or  And

1  2  3  4

5  6  7  8

The user can select "Or" / "And" logic of the selected Binary inputs.

Symbols description:

<input checked="" type="checkbox"/>	Means binary input is activated and the trigger mode is automatically detected.
<input checked="" type="checkbox"/>	Means binary input is activated and the trigger mode only accepts the raise signal(0 -> 1).
<input checked="" type="checkbox"/>	Means binary input is activated and the trigger mode only accepts the drop signal(1 -> 0).
<input checked="" type="checkbox"/>	Means binary input is deactivated.

The status of each input ports is automatically saved while the testing has started. All of the ports detects the turnover trigger signals independently.

The turnover conditions of each binary inputs must fulfill the [Deglitch time](#)<sup>43</sup>.

### 1.6.4 Result View

Result view include "Action Time" and "Action Value" 2 tabs;

Result View	Time Signal View	Impedance View	Wiring View
Action Time			
Action Value			
	Binary In	Pickup Time	Drop Time
▶	1	No Trip	No Trip
	2	No Trip	No Trip
	3	No Trip	No Trip
	4	No Trip	No Trip
	5	No Trip	No Trip
	6	No Trip	No Trip
	7	No Trip	No Trip
	8	No Trip	No Trip

Column explains:

Binary In	List all Binary input ports
Pickup Time	Display the run-time Pickup time result.
Drop Time	Display the run-time Drop off time result. This column valid only while "Pickup & Drop" option enabled.
Variable	List all the currently variable settings.
Pickup Value	Display the pickup value according to the trip time and variables.
Drop Value	Display the drop-off value according to the trip time and variables.
Dr/Pu Factor	Calculate the Dr/Pu factor according the pickup and drop-off values.

### 1.6.5 Impedance View

Impedance view is separated by analog group outputs and will be automatically linked to the currently selected fault type.

The Impedance view always shows the characteristic in secondary value of the relay settings.

When the test mode is selected as Z-I, Z-V, Z-Zs, Z%-I, Z%-V, Z%-Zs Const modes, the user can pickup a test impedance from the impedance view with click of a mouse.

### 1.6.6 Time Signal View

Time Signal View always displays the chart of tested output signal sequence and Binary I/O status. This chart is calculated before testing, and redrawn after finishing a shot test; and this TimeChart is

only available for the "Auto Step" mode.

Buttons & Input fields:

Zoom	Set the scaling of zoom, default scaling set as 1.1;
Offset	Set the definite offset time from the start signal.
Optimize	Quickly zoom the TimeChart to the default scaling.
Show	Allow selectable the signals channel that you want to show on the TimeChart.
Move	A toggle button to activate/deactivate the "Move" function to move the graphic right/left.
Export	Allow the current TimeChart to to be saved as a comtrade format file for replay purpose.

Place the focus on the signal view and scrolling the mouse can continuously zoom in/out the signals. Hold down and drag the mouse to draw a rectangular shape to zoom in the selected area.

### 1.6.7 Wiring View

Display the corresponding wiring diagram according to the power amplifier output configuration in the hardware configuration. (for power amplifier analog output only)

## 1.7 Ramping

The Ramping module allows the user to manage a ramping table to include series of ramping multiple states, each states equates an auto-mode procedure of AC test module.

### Prerequisites for testing

It is not necessary set the [Test Object](#)<sup>39</sup> prior to testing, but this setting will be helpful in the testing.

Define the hardware, the routing and wiring and trip logic.

Define and manage the test states, and the variables, start value, stop value, step value, ramping time etc in the state.

Define the prefault state, interval time as demand.

### States and Variables management

Add State	Add a new state
Add Variable	Add a new variable under the current state
Remove	Delete a variable, if the variable is the only variable of the state, the state will be deleted.
Copy	Copy current state as a new state.
Up	Move current state to be before the previous state.
Down	Move current state to be after the next state.
	Move the cursor between all the states.

Column define:



Group	Select the group to apply the variables.
Channel	Select the analog output channels to apply the variable. The selectable list will refresh as per to the test mode changed.
Quantity	A manifestation of the selected variable. It will refresh as the variable changes.
From	The starting value that the variable will ramp from.
To	The stop value that the variable will ramp to.
Step	The step value that the variable will be changed to during the ramping process.
$\Delta t$	Ramping time of each steps.
Test time	This time is automatically calculated as per to the From, To, Step, Time settings.
Trigger	The trigger only available when the prefault activated.

### Prefault & Fault Interval

<input checked="" type="checkbox"/> Prefault	Enable this option to activate the prefault state in pulse-ramping mode. The prefault output value allows custom settings, usually $V=V_{nom}$ , $I=0.0A$ ;
<input checked="" type="checkbox"/> Output once only	Enable this option will limit the prefault output state effective only in the first run time.
<input type="radio"/> Time	Define the output time for prefault state.
<input type="radio"/> Binary + Time	Prefault state will switch to fault state by a Binary inputs command or once the time was met.
<input type="radio"/> Key-Press	Prefault state will switch to fault state by a keyboard command.
<input checked="" type="checkbox"/> Fault Interval	Enable this option to add a state after the fault state. The time and value of fault interval allows custom settings, usually $V=0.0V$ , $I=0.0A$ ; Enable this option will shift to the pulse ramping mode.

### Fault state output mode

<input checked="" type="radio"/> Continuous waveform	Set the output phase angle as continuous waveform while state changing.
<input type="radio"/> Absolute Phase Setting	Set the output phase angle as absolute setting while state changing.

### U Aux-N config

Set the U Aux-N channel output during the shot testing.

Manual	This mode allows the user to manually define the U Aux-N output.
+U <sub>0</sub> , -U <sub>0</sub> , + $\sqrt{3}$ *U <sub>0</sub> , - $\sqrt{3}$ *U <sub>0</sub>	These modes will automatically calculate the U Aux-N output from the vector sum of 3-phase network.

+3U0,-3U0, +√3*3U0,- √3*3U0	
-----------------------------------	--

### 1.7.1 Set Mode of Analog Output

The variables list will refresh according to the analog test mode changes. Allow the user to select different kinds of variables.

Analog outputs provide 11 set of modes for 3-Phase network.

1. Direct	Set Line-Neutral values.
2. Line-Line	Symmetrical, allow the setting of line-line voltage, V0, phase currents and angles. All the frequency value is got from Fnom of Device tab in Test Object.
3. Symmetrical	Provide the setting for V1, V2, V0, I1, I2, I0 and angles.
4. Powers	Provide the setting for real power(W), reactive power(var), phase voltages and angles.
5. Fault value	Provide the setting for fault type, voltage, current and angle.
6. Z-I Const	Provide the setting for the fault type, fault impedance and test current. The fault voltage is calculated by module. If the fault voltage is greater than Vnom*0.9, the module will automatically reduce the testing current.
7. Z-V Const	Provide the setting for the fault type, fault impedance and test voltage. The fault current is calculated by the module. If the fault current is greater than Imax output, then the module will automatically reduce the testing voltage.
8. Z-Zs Const	Provide the setting for the fault type, fault impedance and SIR, the fault current and voltage are calculated by the module. $ZS = ZL * SIR$ , ZL is line impedance, by default, the grounding factor of ZS equals to ZL's grounding factor.
9. Z%-I Const	Provide the setting for the fault type, fault impedance is in % of the selected relative zone impedance, and the test current, the fault voltage is calculated by the module. If the fault voltage is greater than Vnom*0.9, the module will automatically reduce the test current.
10. Z%-V Const	Provide the setting for the fault type, fault impedance is in % of the selected relative zone impedance, and the test voltage, the fault current is calculated by the module. If the fault current is greater than Imax output, module will automatically reduce the test voltage.
11. Z%-Zs Const	Provide the setting for the fault type, fault impedance is in % of the selected relative zone



impedance and SIR,  $Z_S = Z_L * SIR$ ,  $Z_L$  is line impedance, by default, the grounding factor of  $Z_S$  equals to  $Z_L$ 's grounding factor.

When selecting the test mode as Z-I, Z-V, Z-Zs, Z%-I, Z%-V, Z%-Zs Const modes, the user can pickup a test impedance from the impedance view with a mouse click to get the test point.

In these modes, the grounding factor and test line length will automatically use the parameters defined in the "[Distance Object](#)"<sup>43</sup> to do the calculations.

## 1.7.2 Ramping mode

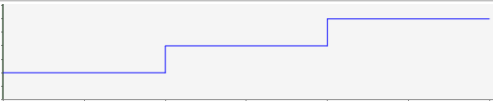
Ramping modes is different according to whether the mode is active during the "Prefault" and "Interval time" period.

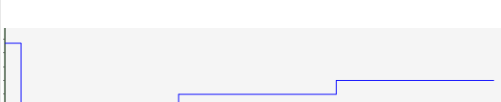
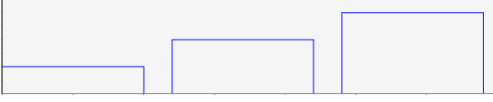
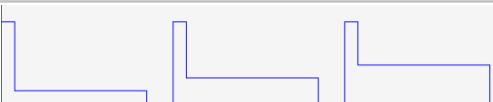
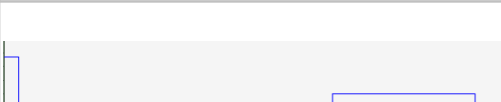
Prefault & Fault Interval	Disabled "Output once only"	Enabled "Output once only"
Normal ramping mode: <input type="checkbox"/> Prefault <input type="checkbox"/> Fault Interval		n/a
Ramping with Prefault: <input checked="" type="checkbox"/> Prefault <input type="checkbox"/> Fault Interval		
Ramping with Fault Interval: <input type="checkbox"/> Prefault <input checked="" type="checkbox"/> Fault Interval		n/a
Ramping with Prefault and Fault Interval: <input checked="" type="checkbox"/> Prefault <input checked="" type="checkbox"/> Fault Interval		

## 1.7.3 Fault Trigger Logic

Result Trigger Logic





Or       And

1     2     3     4

5     6     7     8

The user can select "Or" / "And" logic of the selected Binary inputs.

Symbols description:

	Means binary input is activated and the trigger mode is automatically detected.
	Means binary input is activated and the trigger mode only accepts the raise signal(0 -> 1).
	Means binary input is activated and the trigger mode only accepts the drop signal(1 -> 0).
	Means binary input is deactivated.

The status of each input ports is automatically saved while the testing has started. All of the ports are independent as they detect the turnover trigger signals.

The turnover conditions of each binary inputs must fulfill the [Deglitch time](#)<sup>□43</sup>.

#### 1.7.4 Results view

Result View include "Ramp Measurements" and "Calculated Condition" 2 parts.

Result View										
Vector	Time Signal View	Impedance View								
Ramp Measurements										
Name	Ramp	Group	Signal	Setting	Dev. -	Dev. +	Actual	Dev.	T. Trip	Assessment
Result1	St.1	Group1	Var.1	0.000V	0.000V	0.000V	---	---	---	Non Test
Result2	St.2	Group1	Var.1	0.000V	0.000V	0.000V	---	---	---	Non Test
Calculated Condition										
Name	Function	X	Y	Setting	Dev. -	Dev. +	Actual	Dev.	Assessment	
Calculate1	X/Y	Result1	Result1	0.000	0.000	0.000	---	---	Non Test	

Add      Delete

#### Ramp measurements

The row of results is generated as the states and variables are defined, the user can add the settings and deviations for automatic assessment.

Columns:	
Name	It can be customized by the user to identify the evaluated item in the output report;
Ramp, Group, Signal	Automatically corresponds to the corresponding variable channel of the current ramping state;
Setting	Enter a reference value for evaluation; usually a set value for a voltage, current, or impedance; (corresponding to the current variable)
Dev. -	Enter a value for the negative deviation range; (absolute value)

Dev. +	Enter a value for the positive deviation range; (absolute value)
Actual	The actual action value of the currently selected variable; valid after the test finishes;
Dev	According to the setting value and the Actual value, the calculation is obtained.
T.Trip	Actual action time; (for reference only, without evaluation)
Assessment	The program automatically gives the evaluation a conclusion according to the setting value, the actual value and the deviation value.

### Calculated Condition

When there are more than one ramping state, it can be further calculated by calculating the conditions. For example, in order to calculate the return coefficient, the action value can be measured by the ramping state one, and the return value can be measured by the ramping two, and then the return coefficient can be calculated by defining the formula "ramping two / changing one".

Six function equations are provided for the user to select, and then the setting value and positive and negative deviation can be set like the Ramp measurement to automatically evaluate the new results.

#### 1.7.5 Impedance View

Impedance view is separated by analog group outputs and automatically links to the currently selected fault type.

The Impedance view always shows the characteristic in secondary value of the relay settings.

When selecting the test mode as Z-I, Z-V, Z-Zs, Z%-I, Z%-V, Z%-Zs Const modes, the user can pickup a test impedance from the impedance view with mouse click.

#### 1.7.6 Time Signal View

Time Signal View always displays the chart of the tested output signal sequence and Binary I/O status, this chart is calculated before the test, and redrawn after finishing a shot test; and this TimeChart is only available for the "Auto Step" mode.

Buttons & Input fields:

Zoom	Set the scaling of zoom, default scaling set as 1.1;
Offset	Set a definite offset time for the start signal.
Optimize	Quickly zoom the TimeChart to default scaling.
Show	Allow to select the signals channel that you want to show on the TimeChart.
Move	A toggle button to activate/deactivate the "Move" function to move the graphic to the right/left.







Export	Allow to save the current TimeChart to a comtrade format file for replay purpose.
--------	-----------------------------------------------------------------------------------

Place the focus on the signal view and scroll the mouse to continuously zoom in/out the signals. Hold down and drag the mouse to draw a rectangle to zoom in the selected area.

## 1.8 StateSequencer

This module allows a sequence of states to be defined. This can be used for testing the trip times or other time measurements.

### 1.8.1 States Menu Bar

 Add	Append a state to the last one.
 Insert	Insert a state before the current state.
 Copy	Copy the current state and append to the last one.
 Delete	Delete the current state.
 First Previous Next Last	Navigate the state to First/Previous/Next/Last.
 Move Up Move Down	Exchange the state sequence with previous (Up) or next (Down) state.

### 1.8.2 State Table

Listed all the states in table mode.  
Include trigger conditions, binary input and output configurations.  
Use "State" menu bar control the states. (Add, Insert, Copy and Delete etc.)

### 1.8.3 Setting View

#### 1.8.3.1 Analog Output

##### Set mode

Set mode provides 11 set of modes for 3-Phase network.

1. Direct	Line-Neutral
2. Line-Line	Symmetrical, allow to set the line-line voltage, V0, phase currents and angles, All the frequency value is got from Fnom of Device tab in Test Object.
3. Symmetrical	Provide the settings for V1, V2, V0, I1, I2, I0 and angles.
4. Powers	Provide the settings for real power(W), reactive power(var), phase voltages and angles.
5. Fault value	Provide the settings for fault type, voltage, current and angle.
6. Z-I Const	Provide the settings for the fault type, fault impedance and angle or resistance R and reactance X, with constant current. The fault voltage is calculated by the module.
7. Z-V Const	Provide the settings for the fault type, fault impedance and angle or resistance R and reactance X, with constant voltage. The fault current is calculated by the module.
8. Z-Zs Const	Provide the settings for the fault type, fault impedance and angle or resistance R and reactance X, with constant SIR(ZS/ZL). The fault current and voltage are calculated by the module.
9. Z%-I Const	Provide the settings for the fault type, fault impedance in % of line length, constant angle, with constant current. The fault voltage is calculated by the module.
10. Z%-V Const	Provide the settings for the fault type, fault impedance in % of line length, constant angle, with constant voltage. The fault current is calculated by the module.
11. Z%-Zs Const	Provide the settings for the fault type, fault impedance in % of line length, constant angle, with constant SIR(ZS/ZL), the fault current and voltage are calculated by the module.

When selecting the test mode as Z-I, Z-V, Z-Zs, Z%-I, Z%-V, Z%-Zs Const modes, the user can pickup a test impedance from the impedance view with a mouse click to get the test point.

The grounding factor and test line length will use the parameters defined in the "[Distance Object](#)"<sup>43</sup> to do the calculations.

##### dv/dt & di/dt

Click the "dv/dt, di/dt" button in the parameter settings area to enter

the advanced options setting, which allows the user to make  $dv/dt$ ,  $di/dt$  and  $df/dt$  **linear changes** to the values of any channel in a state; The initial value of the changed channel is set in the outputs parameter interface, the  $dv/dt$ ,  $di/dt$ ,  $df/dt$  and final values can only be set in the advanced settings view.

The user can also set the closing angle of the current state and the superimposed a DC offset with a constant time attenuation.

**Note:**

- The time period of  $dv/dt$  and  $df/dt$  is limited by the total time duration of the current state. If the state time is longer than that of  $dv/dt$ ,  $di/dt$  or  $df/dt$ , then the Voltage or Frequency outputs will remain the end value of  $dv/dt$ ,  $di/dt$  or  $df/dt$  until the end of the state.
- When the "Advanced" setting is activated, the border of the "Advance" button will turn **red**.

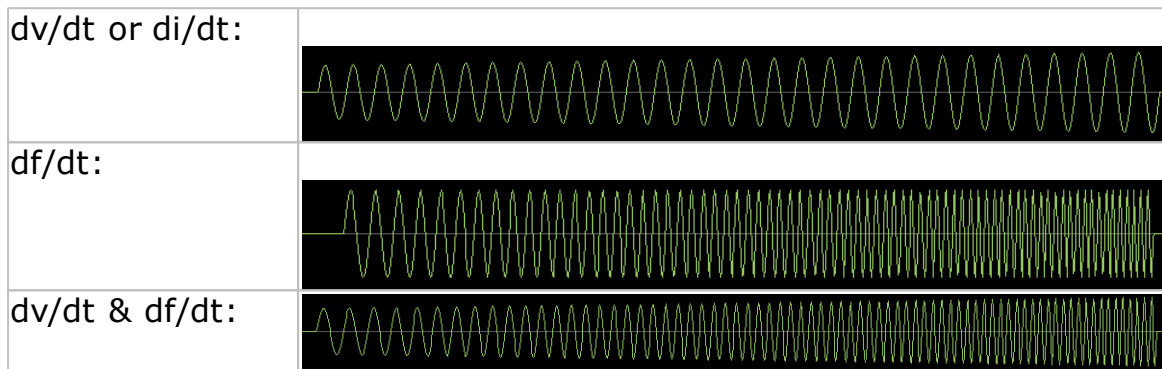

### 1.8.3.2 Trigger Condition

Define the fault trigger conditions.

Time	Trigger by time settings.
Binary	Trigger by binary input settings logic.
Binary + Time	Trigger by both of binary input settings logic and time settings, the smaller of the two will be used.
Key-press	Trigger by keyboard command pressed
GPS or IRIG-B	Trigger by a GPS or IRIG-B time setting, usually with a PPS or PPM signal.

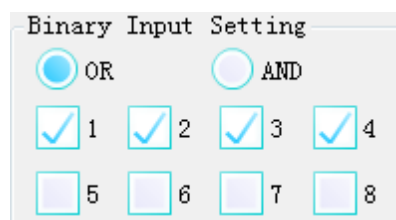



While the trigger condition is set as "Binary" or "Binary+Time", the user can select "Or" / "And" logic of the selected Binary inputs.

Symbols description:

<input checked="" type="checkbox"/>	Means binary input is activated and is set as the automatically detecting trigger mode.
-------------------------------------	-----------------------------------------------------------------------------------------



	Means binary input is activated and the trigger mode only accepts the raise signal(0 -> 1).
	Means binary input is activated and the trigger mode only accepts the drop signal(1 -> 0).
	Means binary input is deactivated.

The status of each input ports are automatically saved while the testing has started. All of the ports are independent as they detect the turnover trigger signals.

The turnover conditions of each binary inputs must fulfill the [Deglitch time](#)<sup>43</sup>.

### 1.8.3.3 Binary Output Setting

Allow the binary outputs to be selectable. The selected binary output will turnover in the specified states.

### 1.8.3.4 General

repeat <input type="text" value="0"/> Count	Number of repeated loops of all states.
---------------------------------------------	-----------------------------------------

### 1.8.3.5 Others

Output mode	
<input checked="" type="radio"/> Continuous waveform	Set the output phase angle as continuous waveform while state changing.
<input type="radio"/> Absolute Phase Setting	Set the output phase angle as absolute setting while state changing.

Others	
<input type="checkbox"/> Do not output this state	Enable this option to disable current state outputs in the sequence.

U Aux-N config	
Set the U Aux-N channel output during the shot testing.	
Manual	This mode allows the user to manually define the U Aux-N output.
+U0, -U0, +√3*U0,-√3*U0 +3U0,-3U0, +√3*3U0,- √3*3U0	These modes will automatically calculate the U Aux-N output from the vector sum of 3-phase network.

## 1.8.4 Other View

Other View in StateSequencer module include Result view, Vector view, Wiring view, Time signal view, and Impedance view.

### 1.8.4.1 Result Evaluation

The result evaluation is divided into time evaluation and status assessment;

When the state sequence is tested repeatedly, the resulting evaluation is only for the first sequence.

#### 1.8.4.1.1 Time evaluation

Time evaluation allows the users to customarily define any evaluation, and the evaluation results are based on the actual tripping time of the state sequence. This evaluation is only for the tripping time. If you want to evaluate the action status of the binary inputs, please use the [State evaluation](#)<sup>67</sup>.

Time evaluation		State evaluation							
Name	Ignore previous	Start	Stop	Tnom	Dev(-)	Dev(+)	Tact	Dev	Evaluate
	---	State1	State1	0.000s	0.000s	0.000s	0.000s	0.000s	NotTest
	---	State1	State1	0.000s	0.000s	0.000s	0.000s	0.000s	NotTest

Columns:	
Name	It can be customized by the user to identify the evaluated item in the output report;
Ignore previous	When "0-> 1" or "1-> 0" is selected in the "start" item, it is optional to filter interference signals that are not used previously; while the default is blank, it automatically starts from the beginning of state 1.
Start	Select the state while the timer starts, start the timing at the beginning of the state; you can also choose to start the timer according to the action logic "0-> 1" or "1-> 0"; (used in conjunction with ignore previous)
Stop	Select the state while the timer ends, start the timing at the beginning of the state; If the "ignore previous" option is activated, then the evaluation results for the "stop" status can only be obtained after the "ignore previous" state.
T.nom	Enter a reference value for evaluation; usually a set value for trip time;
Dev (-)	Enter a value for the negative deviation range; (absolute value)
Dev (+)	Enter a value for the positive deviation range; (absolute

	value)
T.act	Actual action time; after the test is completed, it is calculated automatically by the "Start" and "stop" state options;
Dev	According to the T.nom value and the T.Act value, the calculation is obtained.
Evaluate	The program automatically gives the evaluation conclusion according to T. Nom, T.act and deviation value.

#### 1.8.4.1.2 State evaluation

Time evaluation allows the users to customarily define any evaluation, and the evaluation results are based on the actual binary input status of each sequence. This evaluation is only for the binary inputs status. If you want to evaluate the tripping time, please use the [Time evaluation](#)<sup>D66</sup>.

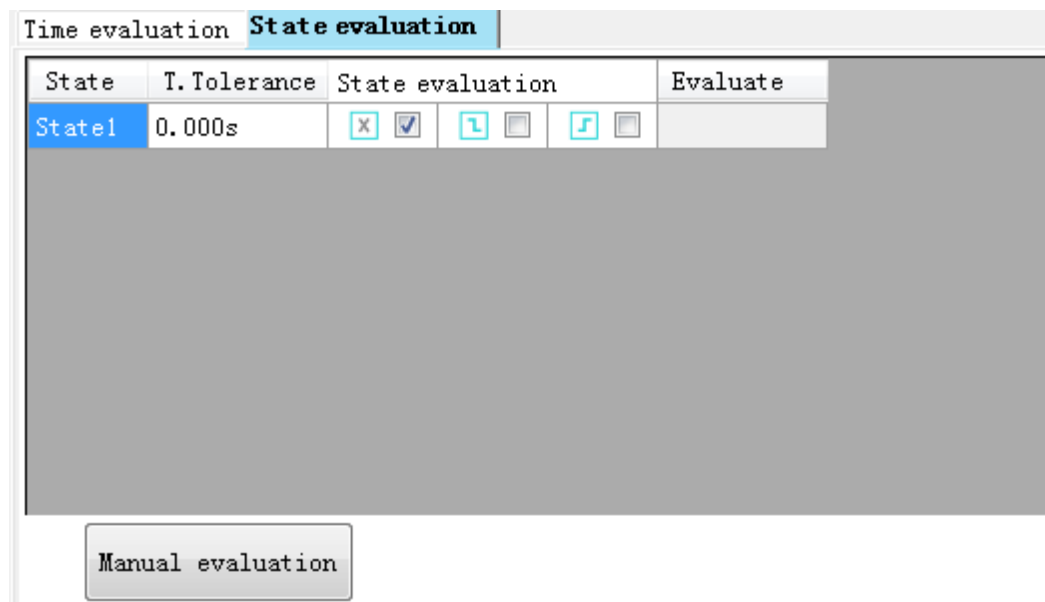

All states are automatically listed here. The users can select the results to be evaluated for each state, and after the test is completed, the program is automatically evaluated according to the action logic of the binary input.

<input checked="" type="checkbox"/> <input checked="" type="checkbox"/>	No evaluation.
<input checked="" type="checkbox"/> <input checked="" type="checkbox"/>	Evaluate whether the binary input logic of the current state is from 1-> 0 (from closed to open)
<input checked="" type="checkbox"/> <input checked="" type="checkbox"/>	Evaluate whether the binary input logic of the current state is from 0-> 1 (from open to closed)

After the test is complete, the user can press "manual evaluation" to modify the status evaluation results, the modified evaluation results only affect the output report.

### 1.8.4.2 Time Signal View

Time Signal View always displays the chart of the tested output signal sequence and Binary I/O status, this chart is calculated before test, and redrawn after finishing a shot test.

Buttons & Input fields:

Zoom	Set the scaling of zoom, default scaling set as 1.1;
Offset	Set the definite offset time from the start signal.
Optimize	Quickly zoom the TimeChart to the default scaling.
Show	Allow to select the signals channel that you want to show on the TimeChart.
Move	A toggle button to activate/deactivate the "Move" function to move the graphic right/left.
Export	Allow to save the current TimeChart to a comtrade format file for replay purpose.

Place the focus on the signal view and scrolling the mouse can continuous zoom in/out the signals. Hold down and drag the mouse to draw a rectangular to zoom in the selected area.

### 1.8.4.3 Impedance View

Impedance view is separated by the analog group outputs and is automatically refreshed to the currently selected fault type.

The Impedance view always shows the characteristic in secondary value of the relay settings.

When selecting the test mode as Z-I, Z-V, Z-Zs, Z%-I, Z%-V, Z%-Zs Const modes, the user can pickup a test impedance from the impedance view with a mouse click.

### 1.8.4.4 Wiring View

Display the corresponding wiring diagram according to the power amplifier output configuration in the hardware configuration. (for power amplifier analog output only)

## 1.9 Harmonic

Harmonic test module allow the user to manually or automatically output 2 groups of voltages, currents and frequencies statically or as ramped outputs with specific superposition harmonics.

### Prerequisites for testing

It is not necessary to set the Test Object prior to testing.

Define the hardware, the routing and wiring and trip commands.





Use "+" mark in the columns head of main view to add new harmonic orders to be superposition.

Define the Variables, Test mode, Prefault, etc in the main view.

#### Columns define

THD	Total harmonic distortion
RMS	Root mean square value (fundamental + harmonics)
1	RMS of fundamental wave (include magnitude and phase angle)
+	Press to add and define customized harmonics (include magnitude and phase angle, the harmonic angle is based on the fundamental wave); The harmonics are selectable from 2~63 times. Once the harmonic is defined, the "+" symbol will be shown as the harmonic times, press it again can delete it.

#### Buttons and Options

	In manual mode, Increase the value of the current variables; In automatic mode, start fault simulation in positive direction by step value. If step value > 0, then the limit value must > currently variable value setting; else while step value < 0, the limit value must < currently variable value setting. Keyboard shortcut is "F2"
	The function reversed to  button. Keyboard shortcut is "F3"
	Lock the current output value, allow to set the analog value to your liking, then release this button for a transient signal. This button is only available in manual mode.
<input checked="" type="checkbox"/> Stop on trigger	Enable this option to automatic stop outputs while the received trigger command has met the Result Trigger Logic.
<input checked="" type="checkbox"/> Auto Step	Enable this option will shift to the auto-step mode.
<input type="checkbox"/> Display in percentage	Enable this option to display the THD and Harmonics magnitude in percentage value from the fundamental voltages or currents.

#### Prefault & Fault Interval

Prefault & Fault Interval are available only when "Auto Step" is activated

<input checked="" type="checkbox"/> Prefault	Enable this option to activate the prefault state in pulse-ramping mode. The prefault output value allows for custom setting, usually $V=V_{nom}$ , $I=0.0A$ ;
<input checked="" type="checkbox"/> Output once only	Enable this option will limit the prefault output state effective only in the first run time.

<input type="radio"/> Time	Define the output time for pre-fault state.
<input type="radio"/> Binary + Time	Prefault state will switch to the fault state by a Binary inputs command or once the time was met.
<input type="radio"/> Key-Press	Prefault state will switch to the fault state by a keyboard command.
<input checked="" type="checkbox"/> Fault Interval	Enable this option to add a state after the fault state. The time and value of the fault interval allows for custom settings, usually V=0.0V, I=0.0A; Enable this option will shift to the pulse ramping mode.

### Variable setting

Provide variable selection, it can be any channel(s), order and any quantity of amplitude, phase angle or frequency.

### 1.9.1 Harmonic Characteristic

Harmonic characteristic shows the 10 cycles length of the fundamental output signal;

Buttons & Input fields:

Zoom	Set the scaling of zoom, default scaling set as 1.1;
Offset	Set the definite offset time from the start signal.
Optimize	Quickly zoom the TimeChart to the default scaling.
Show	Allow the user to select the signals channel that you want to show on the characteristic.
Move	A toggle button to activate/deactivate the "Move" function to move the graphic to the right/left.

Place the focus on the characteristic view and scrolling the mouse can continuous zoom in/out the signals. Hold down and drag the mouse to draw a rectangular to zoom in the selected area.

### 1.9.2 Fault Trigger Logic

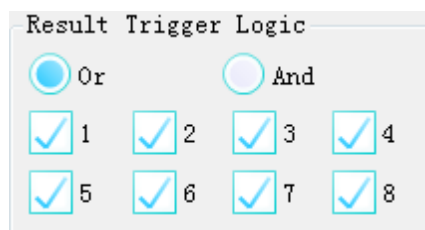

The user can select the "Or" / "And" logic of the selected Binary inputs.

Symbols description:

<input checked="" type="checkbox"/>	Means binary input is activated and the trigger mode is automatically detected.
<input checked="" type="checkbox"/>	Means binary input is activated and the trigger mode only accepts the raise signal(0 -> 1).
<input checked="" type="checkbox"/>	Means binary input is activated and the trigger mode only accepts the drop signal(1 -> 0).

	Means binary input is deactivated.
-----------------------------------------------------------------------------------	------------------------------------

The status of each input ports are automatically saved when the testing has started. All of the ports are independent as they detect the turnover trigger signals.

The turnover conditions of each binary inputs must fulfill the [Deglitch time](#)<sup>43</sup>.

### 1.9.3 Result View

Binary In	List all Binary input ports
Action Time	Display the run-time trip status
Variable	List all the current variable settings
Action Value	Display the trip value according to the trip time and variables.

## 1.10 Frequency Test

The frequency test module provides the functionality to define and perform tests for frequency relays by df/dt, under-frequency, tripping time, dv/dt, under-voltage latch, under-current latch, etc.

The difference of under-frequency / under-voltage protection with other traditional protections.

	Under-frequency / Under-voltage Relay	Tradional relay
Functions	In order to ensure the normal operation of the power network, under-frequency is used to ensure the normal power consumption of important load in order to get rid of the unimportant load when the power load is lacking and the supply is seriously smaller than the demand.	remove the fault equipment in time when the short circuit fault occurs
Protected object	In order to protect the entire power grid	To protect some electrical equipment
Protection principle	When the voltage amplitude on the line (or bus) is felt, the frequency drops slowly below the set value, that is, there is no short circuit fault on the line, but the voltage amplitude is reduced because the load is too large.	When the voltage amplitude on the line (or bus) is felt, the frequency suddenly drops below the set value, that is, a short circuit fault occuring on the line.
The selectivity of the removal device	Removal of normal load in preset order	Removal of fault load

### Prerequisites for testing

It is not necessary to set the Test Object prior to testing.

Define the hardware, the routing and wiring and trip commands.

Select test mode, setting the test values and times of states, add to the test table to be performed.

### Test Mode

This module contains 2 classify modes for under-frequency relays and under-voltage relays.

<b>Under Frequency:</b>	
Frequency	
Time	
df/dt	
Under-U Latch	
Under-I Latch	
<b>Under Voltage:</b>	
Voltage	
Time	
dV/dt	

### Common parameters:

1.	Prefault output	Defined all the analog outputs magnitudes and phase angles. Make the protection relay work properly.
2.	Prefault time	During the prefault state, using the output config with the starting frequency value.
3.	Interval time	No output in this state.
4.	Fault time	Maximum time of fault state automatically calculated by module.
5.	Hold time	A stable state after the variable slipped if no tripping is met.
6.	Nominal Frequency	Use the Fnom value defined in the <a href="#">Device object</a> <sup>42</sup> .

#### 1.10.1 Under-Frequency mode

This classified mode specifies the under-frequency protection functions.



### 1.10.1.1 Frequency

This function aims to check the tripping frequency value of the under-frequency protection.

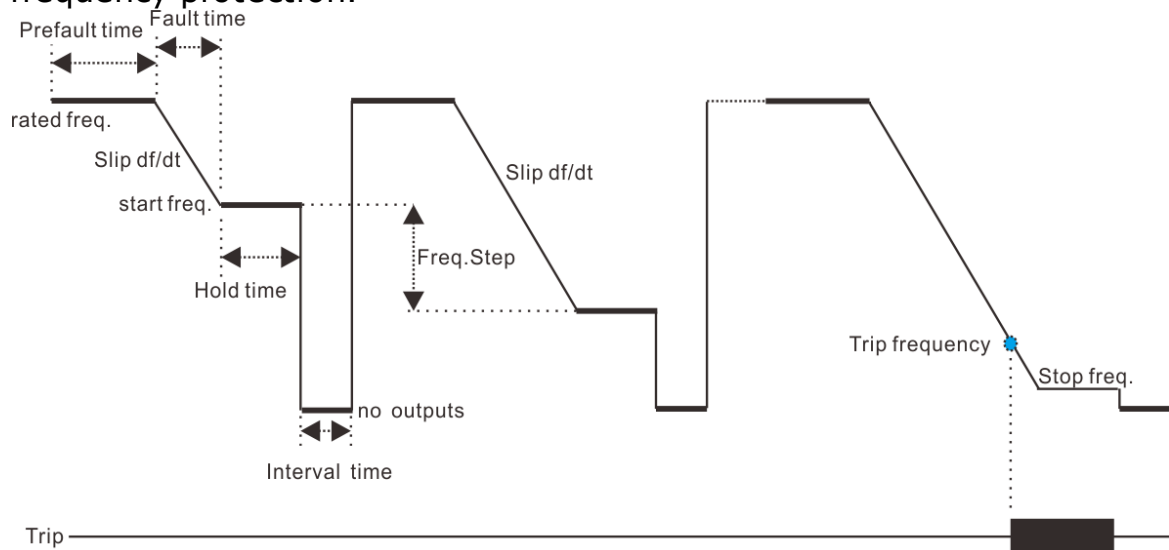

In the Under-frequency test, the "start frequency" and "stop frequency" defined the destination frequency value to be ramped, software controlling the frequency signal from "Rated frequency" slides to the ramping destination.

The "start frequency" is required to be greater than the action frequency of the protection setting. If the protection relay has the "start frequency" requirement, it should also be greater than the "start frequency" of the protection. The "stop frequency" should be set as less than the action frequency of the protection relay to ensure the protection relay can meet the trip conditions.

#### Parameters:

1.	Freq. start	Defined the first frequency on each steps to be reached.
2.	Freq. step	Defined the ramping step frequency value from the start frequency to the destination frequency. Reducing this value can increase the accuracy of test result.
3.	Freq. stop	Defined the destination frequency value; Usually this value should ensure that the protection relay can trip. Note: Normally this value should be greater than 45Hz, it may make the protection relay latched and to ensure an effective test result.
4.	Freq. df/dt	Defined the slip from start frequency to the current stop frequency. Usually this value should be less than the df/dt latch value of protection relay.

### 1.10.1.2 Time

This function aims to check the tripping time of under-frequency protection.

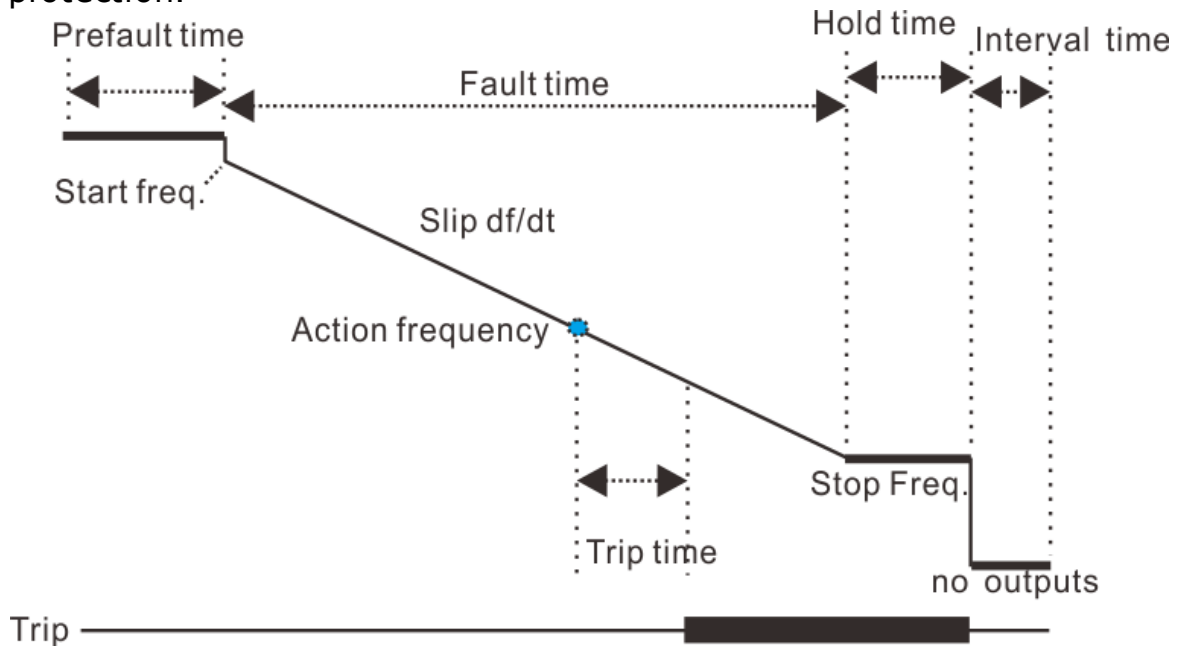

The method of measuring the action time is: the frequency slides from the start value to the stop value, and waits for the protection relay to meet the trip condition. During testing, the stop value should be set slightly less than the action frequency setting of the protection relay to ensure the successful action of tripping.

#### Parameters:

1.	Freq. start	Defined the initial frequency on start. Usually is set to Fnom.
2.	Action frequency	Defined the start point of timer of a particular frequency. Usually this value is the tripping frequency of the protection.
3.	Freq. stop	Defined the destination frequency value.
4.	Freq. df/dt	Defined the slip from the start frequency to the destination frequency. This value must be less than the df/dt latch value of the protection relay.

### 1.10.1.3 df/dt Latch

This function aims to check the df/dt latch value of under-frequency protection.

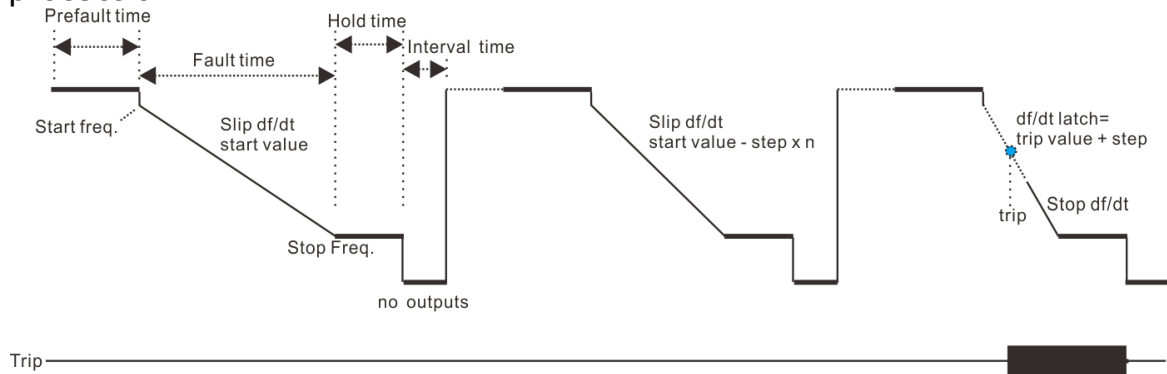

In the df/dt latch test, The frequency slides from the start frequency to the stop frequency according to the defined df/dt slip value, this is a test cycle; the df/dt is fixed in each cycle, and it ramps from "start df/dt" to "stop df/dt" with "step df/dt" settings in every next cycles.

The process of this test is that when the test has started, the start df/dt value set as greater than the slips setting of the protection relay, the protection is in the disallowed action status, and then the df/dt value is adjusted to be less than the slip latch value. While the protection has tripped, at this time, the current df/dt value is recorded, and the df/dt latch value is to be calculated.

#### Parameters:

1.	Freq. start	Defined the initial frequency once each steps have started. Usually is set to Fnom.
2.	Freq. stop	Defined the destination frequency value. Must less than tripping frequency settings.
3.	df/dt start	Defined the start df/dt slip value. This value has to be great than df/dt latch value of the protection relay, to make the protection relay in the lockout status.
4.	df/dt stop	Defined the destination df/dt slip value. This value has to be less than df/dt latch value of the protection relay, to make the protection relay into the trip permit status.
5.	df/dt step	Defined the ramping step df/dt value from start df/dt to destination df/dt. Reducing this value can increase the accuracy of the test result.

### 1.10.1.4 Under-U Latch

This function aims to check the under-voltage latch value of protection.

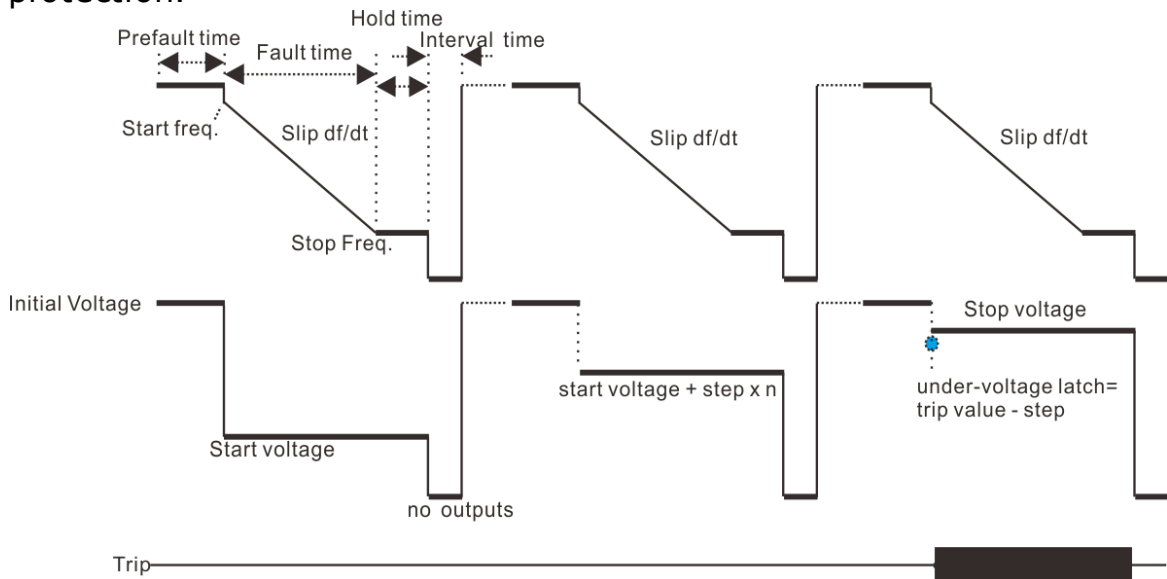

In the under-voltage latch test, The frequency slides from the start frequency to the stop frequency according to the defined slip value, this is a test cycle;

At the same time, there is a fixed voltage output value in every cycle, and it is ramping from "start voltage" to "stop voltage" with "voltage step" settings in every next cycles.

The process of this test is that when the test has started, the "start voltage" is set as less than the under-voltage latch value of the protection, so the protection is in the disallowed action status, and then the voltage value is increased to be greater than the under-voltage latch value. While the protection has tripped, at this time, the current voltage value is recorded, and the under-voltage latch value to be calculated.

#### Parameters:

1.	Freq. start	Defined the initial frequency on the beginning of each steps . Usually is set to $F_{nom}$ .
2.	Freq. stop	Defined the destination frequency value. Needs to be less than the tripping frequency settings.
3.	Freq. df/dt	Defined the slip from the start frequency to the stop frequency. Usually this value should be less than the df/dt latch value of protection relay.
4.	Voltage start	Defined the testing under-voltage start value. This value must make the protection relay into the lockout status.
5.	Voltage stop	Defined the testing under-voltage destination value. This value has to make the protection relay into the trip permit status. Usually it can be set to $V_{nom}$ .

6.	Voltage step	Defined the ramping step voltage from the start to the destination under-voltage. Reducing this value can increase the accuracy of test result.
----	--------------	-------------------------------------------------------------------------------------------------------------------------------------------------

### 1.10.1.5 Under-I Latch

This function aims to check the under-current latch value of protection.

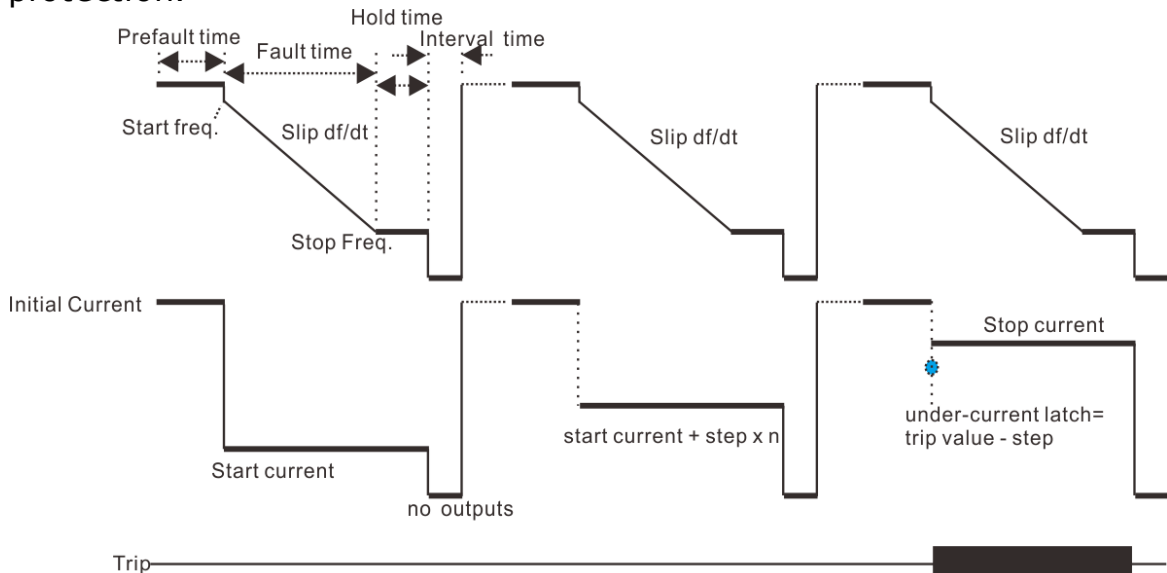

In the under-current latch test, The frequency slides from the start frequency to the stop frequency according to the defined slip value, this is a test cycle;

At the same time, there is a fixed current value outputs in every cycle, and it is ramping from the "start current" to "stop current" with "current step" settings in every next cycles.

The process of this test is that when the test has started, the "start current" is set as less than the under-current latch value of the protection, so the protection is in the disallowed action status, and then the current value is increased to become great than the under-current latch value. While the protection has tripped, at this time, the current value is recorded, and the under-current latch value to be calculated.

#### Parameters:

1.	Freq. start	Defined the initial frequency on each the beginning of each steps. Usually is set to Fnom.
2.	Freq. stop	Defined the destination frequency value. to be less than the tripping frequency settings.
3.	Freq. df/dt	Defined the slip from the start frequency to the stop frequency. Usually this value should be less than the df/dt latch value of protection relay.
4.	Current start	Defined the testing under-current start value. This value must make the protection relay into the lockout status.

5.	Current stop	Defined the testing under-current destination value. This value has to make the protection relay into the trip permit status. Usually it can be set to be great than $1.2 \cdot I_{pickup}$ .
6.	Current step	Defined the ramping step current from the beginning to the destination under-current. Reducing this value can increase the accuracy of test result.

## 1.10.2 Under-Voltage mode

This classified modes specifies for the under-voltage protection functions.

### 1.10.2.1 Voltage

This function aims to check the tripping voltage value of under-voltage protection.

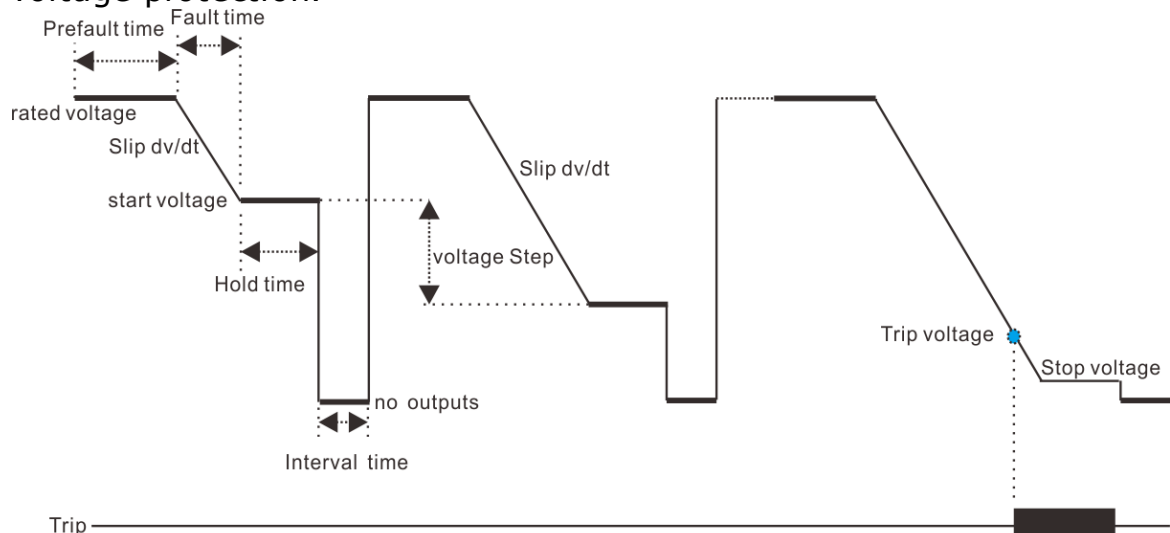

In the Under-voltage test, the "start voltage" and "stop voltage" defined the destination value to be ramped, software controlling the voltage signal from "Rated voltage" slides to the ramping destination.

the "start voltage" is required to be greater than the action under-voltage of the protection setting. "stop voltage" is set as less than the action under-voltage of the protection relay to ensure the protection relay can meet the trip conditions.

#### Parameters:

1.	Voltage start	Defined the initial voltage on each steps start. Usually is set to $V_{nom}$ .
2.	Voltage step	Defined the ramping step voltage value from the starting voltage to the destination voltage. Reducing this value can increase the accuracy of test result.
3.	Voltage stop	Defined the destination voltage value; Usually this value should ensure the protection relay can trip.

4.	Voltage $df/dt$	Defined the slip from the starting voltage to the current stop voltage. Usually this value should be less than the $dv/dt$ latch value of protection relay.
----	-----------------	-------------------------------------------------------------------------------------------------------------------------------------------------------------

### 1.10.2.2 Time

This function aims to check the tripping time of under-voltage protection.

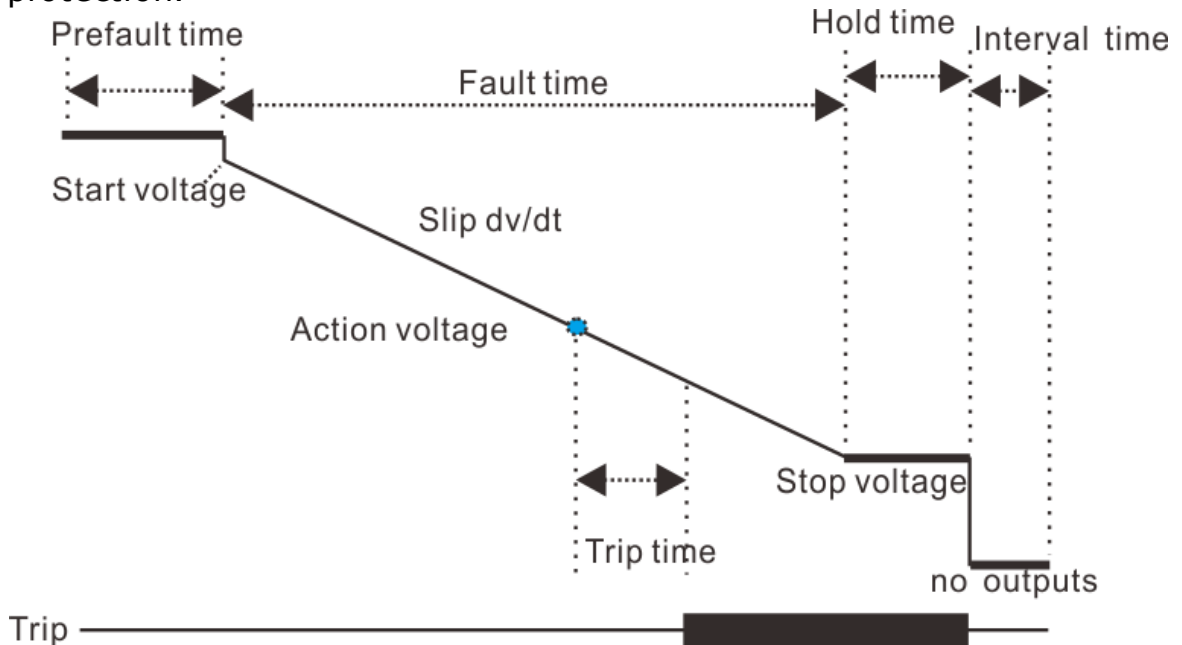

The method of measuring the action time is: the voltage slides from the start value to the stop value, and waits for the protection relay to meet the trip condition. During testing, the stop value should be set slightly less than the under-voltage action setting of the protection relay to ensure successful tripping.

#### Parameters:

1.	Voltage start	Defined the initial voltage on start. Usually is set to $V_{nom}$ .
2.	Action voltage	Defined the starting point of the timer of a particular voltage. Usually this value is the tripping voltage of the protection.
3.	Voltage stop	Defined the destination voltage value.
4.	Voltage $dv/dt$	Defined the slip from the starting voltage to the destination voltage. This value should be less than the $dv/dt$ latch value of protection relay.

### 1.10.2.3 dv/dt Latch

This function aim to check the dv/dt latch value of under-voltage protection.

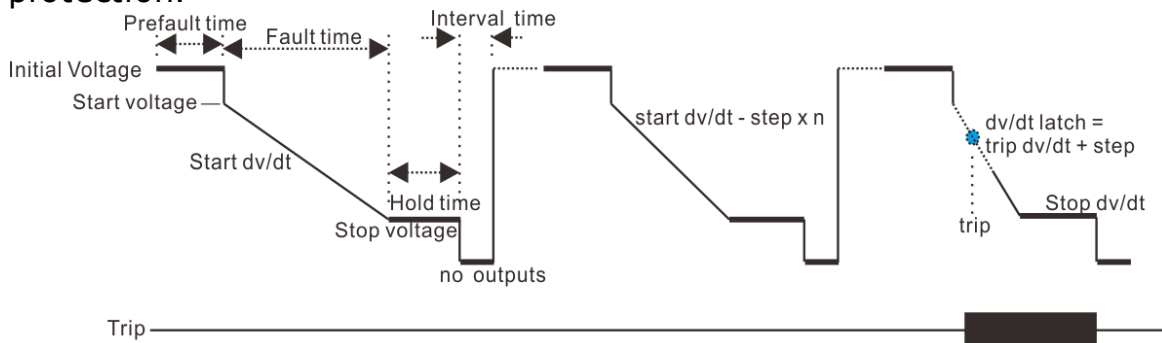

In the dv/dt latch test, The voltage slides from the start voltage to the stop voltage according to the defined dv/dt slip value, this is a test cycle; the dv/dt is fixed in each cycle, and it ramping from "start dv/dt" to "stop dv/dt" with "step dv/dt" settings in every next cycles.

The process of this test is that when the test has started, the start dv/dt value set as greater than the slips setting of the protection relay, the protection is in the disallowed action status, and then the dv/dt value is adjusted to be less than the slip latch value. While the protection has tripped, at this time, the current dv/dt value is recorded, and the dv/dt latch value is to be calculated.

#### Parameters:

1.	Voltage start	Defined the initial voltage on the starting of each steps. Usually is set to Vnom.
2.	Voltage stop	Defined the destination voltage value. Must be less than the under-voltage tripping value.
3.	dv/dt start	Defined the start dv/dt slip value. This value has to be greater than dv/dt latch value of the protection relay, to make the protection relay into the lockout status.
4.	dv/dt stop	Defined the destination dv/dt slip value. This value has to be less than dv/dt latch value of the protection relay, to make the protection relay into the trip permit status.
5.	dv/dt step	Defined the ramping step dv/dt value from the starting dv/dt to the destination dv/dt. Reducing this value can increase the accuracy of test result.



### 1.10.2.4 Under-I Latch

This function aims to check the under-current latch value of protection.

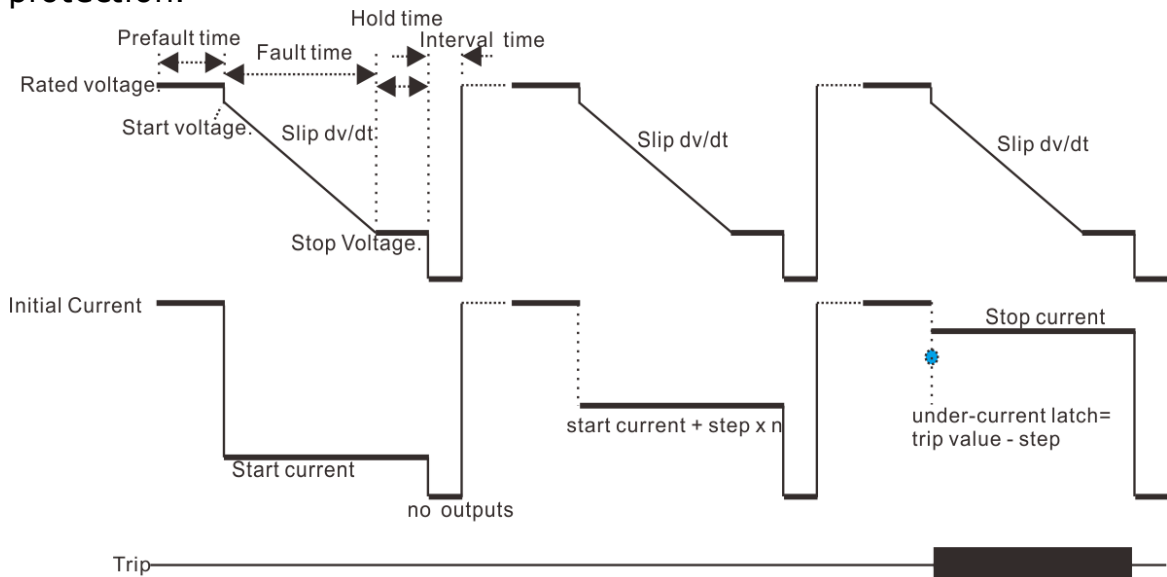

In the under-current latch test, The voltage slides from the start value to the stop value according to the defined slip value, this is a test cycle;

At the same time, there is a fixed current value outputs in every cycle, and it is ramping from "start current" to "stop current" with "current step" settings in every next cycles.

The process of this test is that when the test is started, the "start current" set as less than the under-current latch value of the protection, so the protection is in the disallowed action status, and then the current value is move toward to great than the under-current latch value, while the protection tripped, at this time, the currently current value is recorded, and the under-current latch value to be calculated.

#### Parameters:

1.	Voltage start	Defined the initial Voltage on each steps start. Usually is set to Vnom.
2.	Voltage stop	Defined the destination Voltage value. to be less than under-voltage settings.
3.	Voltage dv/dt	Defined the slip from the start Voltage to the stop Voltage. Usually this value should less than the dv/dt latch value of protection relay.
4.	Current start	Defined the testing under-current start value. This value must make the protection relay into lockout status.
5.	Current stop	Defined the testing under-current destination value. This value have to make the protection relay into the trip permit status. Usually it can be set to great than $1.2 \cdot I_{pickup}$ .
6.	Current step	Defined the ramping step current from start to

	destination under-current. Reduce this value can increase the accuracy of test result.
--	----------------------------------------------------------------------------------------

## 1.11 Transplay

The transplay module has the following functions:

- Allow the user to import the **Comtrade** format transient data file and performs playback;
- With manual trigger, binary trigger, GPS trigger, etc;
- All data of any voltage or current channel are editable and superimposed;
- The output value of each current and voltage channel is adjusted proportionally and converted from the primary value to the secondary value;
- The data of the original record is interpolated and calculated;
- By setting the repetition start time, repeat the interval and repeat times, repeat a certain section of the waveform;
- Prolonging the output time of the normal state or repeating the output of a certain fault waveform;

### Prerequisites for testing

It is not necessary to set the Test Object prior to testing.

Define the hardware, the routing and wiring and trip commands.



Load the transient data file using the  of toolbar, adjust the ratios scaled of the amplitudes of the analog output channels.

### Prefault Output Config

Define the prefault state output area and trigger conditions of fault state.

Time Trigger	Trigger by time settings.
Binary	Trigger by binary input settings logic.
Key-press	Trigger by keyboard command pressed.
GPS or IRIG-B	Trigger by a GPS or IRIG-B time setting, usually is a PPS or PPM signal.
<input checked="" type="checkbox"/> <input type="button" value="Set"/>	Define a fixed value of the prefault state output. If this mode is enabled, the angle of waveform may not be continuous while the state has switched to the fault state.
Start	Defined the prefault area of the transient data to be performed in the prefault state.
End	
Repeat	Number of repeats in the prefault state.

### Fault Output Setting

Max.Fault time	Defined the maximum time limit of the fault state to be playback.
Start	Defined the start time of the transient data to be playback. If the pre-fault state has defined an area, then this start time will automatically continue from the end of the pre-fault waveform.
Frequency	Display the nominal frequency of the transient data to be playback.
<input checked="" type="checkbox"/> Repeat enabled	Enable this option to repeatedly playback an area of the transient data.
Counts	Number of repeats of the playback in the defined fault area.
Start	Defined the start time of the fault area to be playback repeatedly.
End	Defined the end time of the fault area to be playback repeatedly.

### Max value type & CT/PT ratio

<p>Max value type</p> <p><input type="radio"/> P-P    <input checked="" type="radio"/> RMS</p>	<p>Switch the display of the Maximum/Minimum values.</p> <p>P-P: peak to peak RMS: root-mean-square <math>P-P = RMS * \sqrt{2}</math> Comtrade file uses P-P value for record, but Relay test kit always uses RMS value to perform output.</p>
PT Primary/ Secondary	Available for all voltage channels. The transplay module uses this ratio to calculate the real output value while performing playback.
CT Primary/ Secondary	Available for all current channels. The transplay module uses this ratio to calculate the real output value while performing playback.

#### 1.11.1 Channels Combine

 **Combine** The channel combine function on the toolbar allows the users to adjust and calculate the imported waveforms before output;

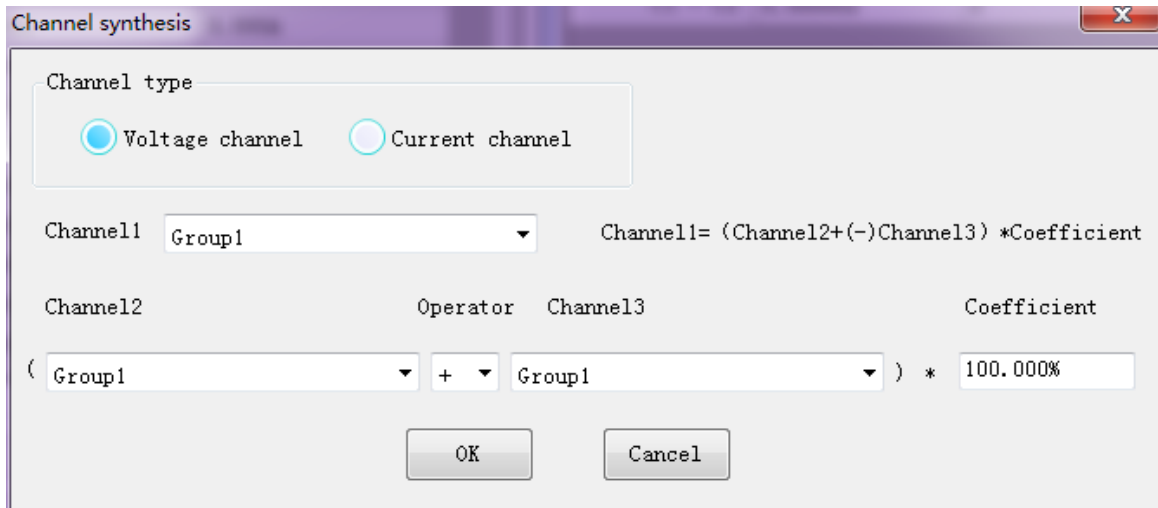

The adjusted waveform data can be applied to the specified channel for playback;  
The user can adjust one channel at a time.

### 1.11.2 Binary Output

The user can set the binary output time while performing the transient playback, it has 2 modes:  
Custom binary output: Binary output action follows the customary "binary config" settings  
Use comtrade binary input settings: Binary output action adjusts according to the comtrade file defined.

### 1.11.3 Advance

The user can select different interpolation algorithm to perform the transient data.

#### Binary input Logic

Defined the binary inputs Logic to be effective during playback of the transient data to measure the trip time.  
The user can select "Or" / "And" logic of the selected Binary inputs. The status of each input ports are automatically saved while the testing starts. All of the ports are independent as they detect the turnover trigger signals.  
The turnover conditions of each binary inputs must fulfill the [Deglitch time](#)<sup>□43</sup>.

### 1.11.4 Information

Display the general information of the loaded comtrade file.

## 1.12 Distance

The distance module provides the functionality to define and perform tests for distanced relays by zone ranges and the trip times defined in the impedance characteristics.

The **Test View** area provides 4 tabs for setting the parameters: [Shot Test](#)<sup>□85</sup>, [Search Test](#)<sup>□86</sup>, [Test Parameter](#)<sup>□86</sup> and [Binary setting](#)<sup>□88</sup>

### Prerequisites for testing

The setting and characteristics of the relay under test has to be defined in the [Distance tab of Test Object](#)<sup>143</sup> prior to testing.

Define the hardware, the routing and wiring and trip commands.

Define the Fault Model, Test time, Trigger config, etc in the "[Test Parameter](#)"<sup>86</sup> tab of the main view.

#### 1.12.1 Shot Test

The aim of the shot test is to check the reaches of the individual zones and trip times with any test points.

### Add Test Points

Tests are defined in the impedance plane. Adding test points can be achieved by right clicking on the impedance plane or entering the test point parameters into the input fields "|Z|, Phi, R, X" by keyboard entry.

All test points are added to a test table. This table will automatically be sorted by the defined fault type and linked to the impedance view.

Base on the selected fault type and test points and fault model (I constant / V constant / Z constant), the voltages or currents at the relay location are calculated automatically and displayed on the Vector View.

#### Buttons:

Add	Add the defined point to the test table below.
Remove	Delete the currently selected test point from the Test points list.
Remove All	Clear the test list

#### Options:

<input type="checkbox"/> Follow line angle change	If active, the impedance of test points will be recalculated by the percentage of the defined zone characteristics after the line angle automatically adjusts.
<input type="checkbox"/> Relative <input type="text" value="0.000%"/>	If active, the impedance of test points will be calculated by the percentage of the defined zone characteristics.
<input type="checkbox"/> Ignore Nominal Time	If active, the time of fault state will use the "maximum fault time". Existing points will not refresh once this option is selected. It is only effective for the new test points.

### 1.12.2 Search Test

The aim of search test is to determine the exact reach and check their trip times of the individual zones by applying several shots along a search line. The number of shots is calculated according to the zones define and the automatic search resolution.

#### Add search Line

Search line is defined by a terminal point (same as shot test) and the line length and line angle, or manually drawn by the mouse from the impedance plane.

Base on the selected fault type and test points and fault model (I constant / V constant / Z constant), the voltages or currents at the relay location are calculated automatically.

Buttons:

Add	Add the defined search line to the test table below.
Add Multi...	Quickly add multiple fault types of a defined search line.
Sequence	Quickly add multiple search lines and multiple fault type based on an origin terminal shot point to the test list.
Remove	Delete the currently selected search line.
Remove All	Clear the test list

Options:

<input type="checkbox"/> Ignore Nominal Characteris	If active, the assessment of search procedure will not be referred to the defined zone characteristics.
-----------------------------------------------------	---------------------------------------------------------------------------------------------------------

### 1.12.3 Test Parameter

#### Fault Model

Fault Model include 3 types as below:

I=Constant test current	Fixed test current. The fault voltage is calculated by the module. If the fault voltage is greater than $V_{nom} \cdot 0.9$ , the module will automatically reduce the test current.
U=Constant test voltage	Fixed test voltage. The fault current is calculated by the module. If the fault current is greater than the $I_{max}$ output, the module will automatically reduce the test voltage.
Z=Constant source impedance	ZS is fixed. The fault current and voltage are calculated by the module according to the impedance of ZS and testing point. The grounding factor of ZS is defined in the <a href="#">Distance Object</a> <sup>143</sup> .

This Model is a global setting used for both shot test and search test.

## Test Time

Each shot consists of 3 states: Prefault, Max-fault and Postfault .

The exact prefault time becomes effective only if the Fault Trigger config is set at "Time" mode.

If "Ignore Nominal Time" or "Ignore Nominal Characteristic" are activated, the "Max Fault time" value is always effective for use in the test. Otherwise, the "Max Fault time" will be automatically calculated by the module according the data of the defined test object.

The presence of voltage in the interval state depends on the location of the PT.(defined in the [Distance Object](#)<sup>43</sup>)

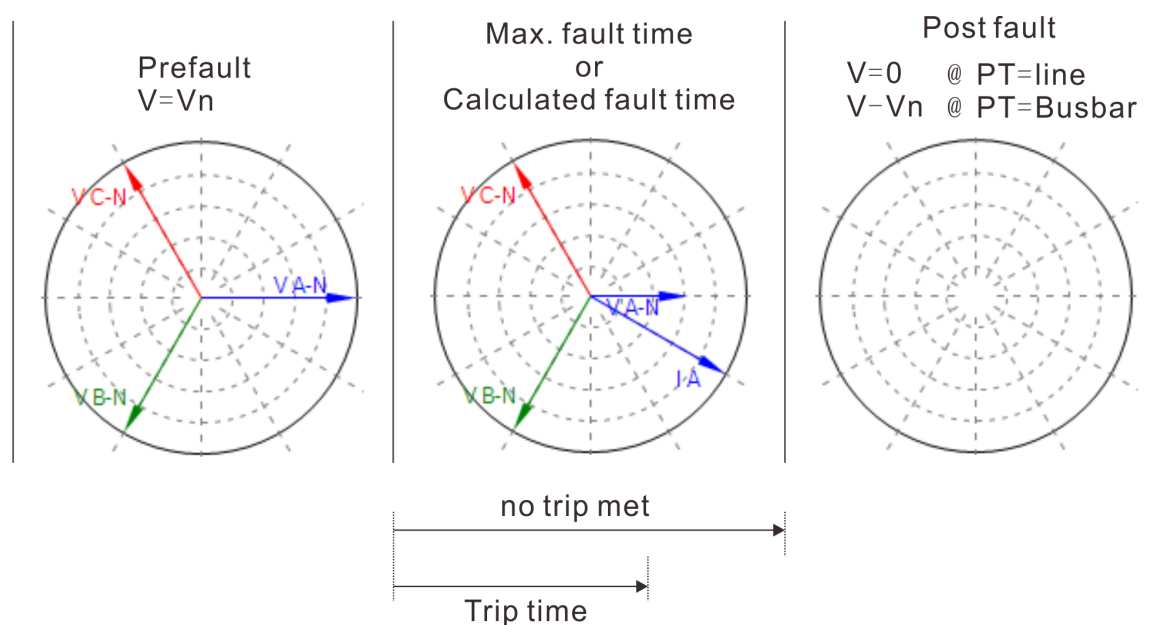

## Trigger Config

Define the fault trigger conditions.

Time	Triggered by the Prefault time
Key-press	Triggered by pressing the keyboard command
GPS or IRIG-B	Triggered by a GPS or IRIG-B time setting. This is usually a PPS or PPM signal.

## CB simulator

Simulate the circuit breaker trip delay and close delay time if the resulting trigger signal is connected from the circuit breaker.

## Load Setting

Current	Load current is effective only in the prefault state
Phase	Offset angle between the load current and voltage.

### Fault Inception

This setting allows using the phase angle of the specified voltage, and hence the angle of the fault current at the inception of the fault. Before the fault turns into a steady state, it is possible to simulate the DC offset transient behavior.

Random	This mode allows the use of a randomly generated fault angle at inception.
Setting	The fault angle at inception can be freely adjusted by entering a value in the close angle field.
DC offset	Enable this option to activate the DC offset transient behavior.
Atten Const	Define the Tconstant of DC offset, during the Tconstant, voltage output is calculated by: $1/(10^{(\Delta t / Tconstant)})$

### U Aux-N config

Set the U Aux-N channel output during the shot testing.

Manual	This mode allows the user to manually define the U Aux-N output.
+3U0,-3U0, +√3*3U0,- √3*3U0	These modes will automatically calculate the U Aux-N output from the vector sum of 3-phase network.
Refer-VA, VB, VC, VAB, VBC, VCA	



## 1.12.4 Binary setting

### Binary Input Define

Allow the user to customize the binary input as per the relay trip command.

### Binary Output definition

This table allows the user to define the binary output independently. Column explain:

Binary output	<p>Activate the specified binary outputs and set the initial status.</p> <p><input type="checkbox"/> Disabled</p> <p> Initialize as NO status.</p> <p> Initialize as NC status.</p>
Reference mode	1. Reference fault: Binary output turnover function starting from the start of fault time.



	2. Reference pre-fault: Binary output turnover function starting from the start of pre-fault time. 3. Reference input: Binary output turnover function starting from the defined binary input trigger.
Reference binary in	Define the reference binary input channel.
Delay time	Binary outputs after this time will be turnover
Hold time	Keeping this time after the binary output has turnover

### 1.12.5 Impedance View

Impedance view is grouped by the fault type and automatically links to the currently selected fault type.

The Impedance view always shows the characteristic in secondary value of the relay settings.

The user can pickup a test impedance from the impedance view with a mouse click.

After completion of the test, "Passed" points will be displayed in "green" color, "Failure" points are displayed in "red" color.

On the right side of the impedance view, 3 magnifying glasses are provided to quickly zoom in, zoom out, or return to the default view.

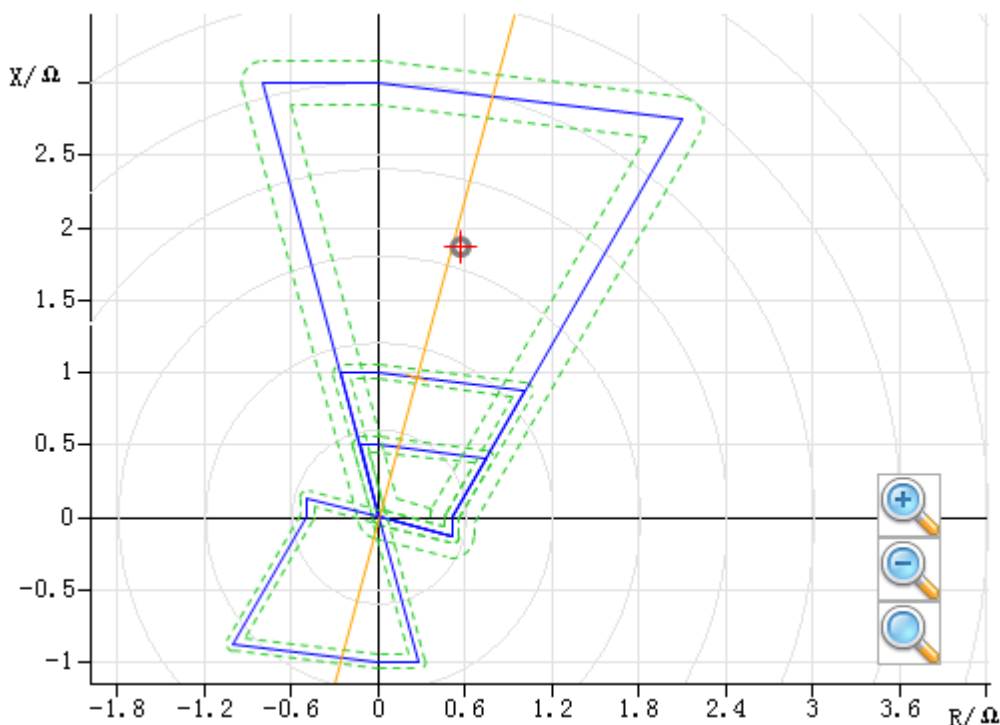

### 1.12.6 Time Signal View

TimeChart always displays the chart of the tested output signal sequence and Binary I/O status. This chart is calculated before the test, and redrawn after finishing a shot test.

Buttons & Input fields:

Zoom	Set the scaling of zoom. The default scaling is set as 1.1;
Offset	Set the definite offset time for the starting signal.
Optimize	Quickly scale the TimeChart to the default scaling.
Show	Allow the user to customarily select the signals channel to be shown on the TimeChart.
Move	A toggle button to activate/deactivate the "Move" function to move the graphic to the right/left.
Export	Allow to save the current TimeChart to a comtrade format file for replay purposes.

Placing the focus on the signal view and scrolling the mouse can continuously zoom in/out of the signals. Hold down and drag the mouse to draw a rectangle to zoom in the selected area.

### 1.12.7 Z/t Characteristic Diagram

At the Z/t plane, show the current Z/t characteristics of the test object and all of the added test points in the same angle from testing list.

## 1.13 Overcurrent

The Overcurrent module allows for testing of the over-current relays with inverse time, definite time, thermal I<sup>2</sup>T and customized curve characteristics.

#### Prerequisites for testing

The setting of the characteristics and tripping element of the relay under test has to be defined in the [Overcurrent tab of Test Object](#)<sup>145</sup> prior to testing.

To test the directional relays, the three voltages are required in addition. This has to be defined in the [Setting Parameter](#)<sup>91</sup> tab.

Define the hardware, the routing and wiring and trip commands.

Define the Max Fault time, Fault voltage, Load current, Prefault and interval time in the Setting Parameter tab.

### 1.13.1 Test Point

In this tab, a single test or multiple tests can be added to the table for testing the tripping characteristic of the relay.

#### Add test points

Adding test points can be achieved by right clicking on the overcurrent Characteristic or manually entering the test point parameters into the input fields "Test Current", "Angle(I)".

All test points are added to a test table. This table will be automatically sorted by the defined fault type to be linked to the Overcurrent Characteristic view.

Based on the selected fault type and test points, the voltages or currents at the relay location are automatically calculated and displayed on the Vector View.

Buttons:

Add	Add the defined point to the test table below.
Add Multi...	Quickly add multiple fault type of a defined test point.
Remove	Delete the currently selected test point from the Test points list.
Remove Type	Delete all the test points of the currently selected fault type.
Remove All	Clear the test list
Check	Perform testing of the currently selected test point.

All test points added into a test list, it will automatically sort while add.

The sort priority is:

1. Fault type
2. Fault angle. (ascending)
3. Fault current magnitude. (ascending)

#### Check Result

All test points assess the Trip time and Pickup current should be within the tolerance bands set at the Current and Time Tolerances at Overcurrent tab of the Test Object.

### 1.13.2 Setting Parameter

#### Max Fault time

Max Fault time	Define the maximum time for the fault output if the trigger condition is not met.
Relative Max Time	Maximum fault time relative to Td. in consideration with the positive tolerance. This value has to be

compare with the max fault time.  
The system always uses the smaller one of these time values.  
(Td: Time index scales the time axis of the curve.)

### Fault Voltage

Enable Fault Voltage	Select this option if you want to apply the fault voltage during the fault state. For directional relays, this option is always activated. For non-directional relays, voltage output may be necessary to avoid tripping of other relay functions.
V Fault LN	These fields define the voltage applied to the faulty phases during the fault state. The LN voltage is applied for all fault types except for the two-phase faults.
V Fault LL	The LL voltage is applied for the two-phase faults only.
Nominal Voltage LN	These fields are for information and values set in the <b>Device</b> tab of <b>Test Object</b> .
Nominal Voltage LL	

### Load Current

Relative Nom	Set the load current as the multiple of Inominal.
Relative Fault current	Set the load current as the multiple the Ifault.
Load angle	The phase angle of the load current.

**Note:** if the added test points on the Overcurrent Characteristic are shown in RED circle, and the assessment shows "Load current too high", that means the test point cannot be tested. This is due to the test module's constraints. Please reduce the current load setting values.

### 1.13.3 Binary setting

#### Binary Input Define

Allow the user to define the binary input for the relay trip command.

#### Binary Output define

This table allows the user to define the binary output independently.  
Column explained:

Binary output	Activate the specific binary outputs and set the initial status. <input type="checkbox"/> Disabled. <input checked="" type="checkbox"/> Initial as NO status.
---------------	---------------------------------------------------------------------------------------------------------------------------------------------------------------------

	 Initial as NC status.
Reference mode	1. Reference fault: Binary output turnover function starting from the start of the fault time. 2. Reference prefault: Binary output turnover function starting from the start of the prefault time. 3. Reference input: Binary output turnover function starting from the defined binary input trigger.
Reference binary in	Define the reference binary input channel.
Delay time	Binary outputs after this time will be turnover.
Hold time	Keep this time after the binary output turnover.

### 1.13.4 Overcurrent Characteristic

Overcurrent Characteristic view is separated by the fault type and automatically links to the currently selected fault type.

After completion of the test, "Passed" points will be displayed in green color, "Failure" points will be displayed in "red" color.

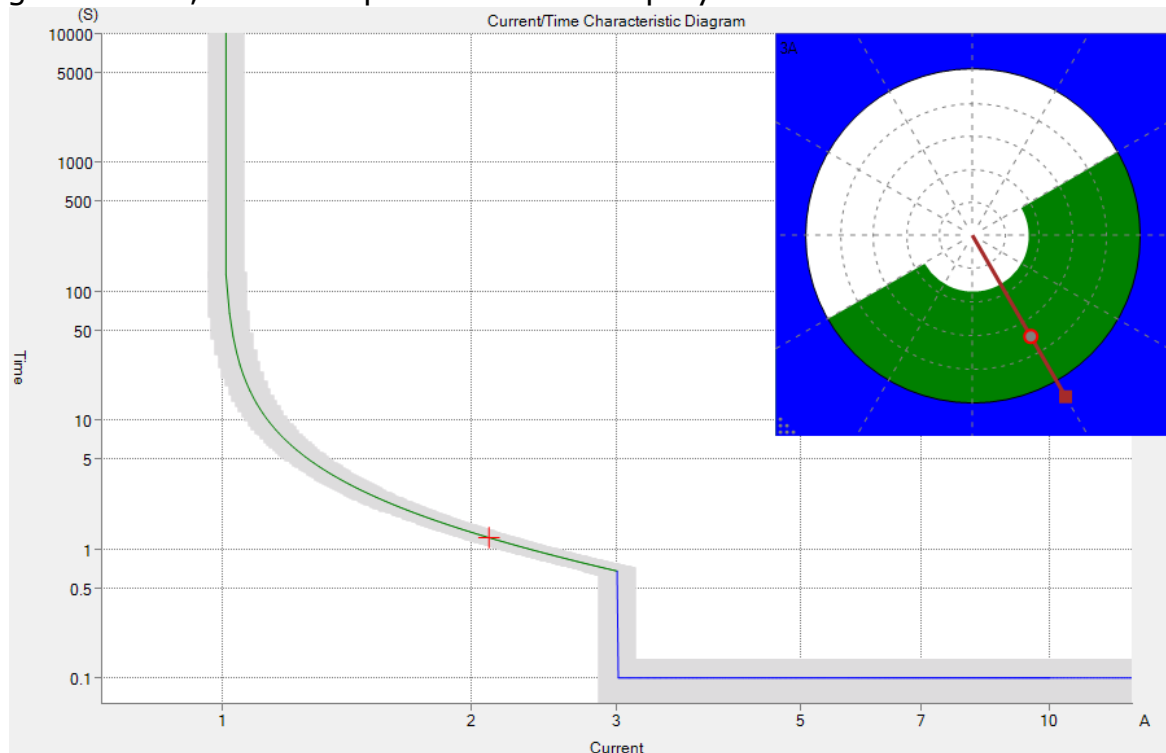

All test points are marked with a cross cursor, the vertical size is adjusted according to the tolerances of trip time, the horizontal size is adjusted according to the I tolerances of the test point.

### 1.13.5 Time Signal View

TimeChart always displays currently selected test point output signal sequence. This sequence is calculated before the test, and redrawn after finishing a shot test.

Buttons & Input fields:

Zoom	Set the scales of zooming. The default scaling is set as 1.1;
Offset	Set the definite offset time from the start signal.
Optimize	Quickly zoom the TimeChart to the default scaling.
Show	Allow the signals channel that you want to show on the TimeChart to be selectable.
Move	A toggle button to activate/deactivate the "Move" function to move the graphic to the right/left.
Export	Allow to save the current TimeChart to a comtrade format file for replay purposes.

Place the focus on the signal view and scroll the mouse to continuously zoom in/out of the signals. Hold down and drag the mouse to draw a rectangle to zoom in the selected area.

## 1.14 Differential

The Differential software has 2 sets of test modules for testing the Bias Curve Characteristic and Harmonic Restrain.

See: [Bias Curve Diff.](#)<sup>□94</sup> and [Harmonic Restraint](#)<sup>□97</sup> modules.

### 1.14.1 Bias Curve Diff.

The Bias Curve Differential module is tested by simulating faults inside and outside of the protected zone. It contains 2 modes, the "[Shot Test](#)"<sup>□95</sup> and "[Search Test](#)"<sup>□96</sup>.

Each test modes creates a test list. The module will perform the list though determining the shot or search.

For a search point consisting of several shots, the Ibias was given and Idiff was calculated and searched.

#### Prerequisites for testing

The setting and characteristics of the relay under test have to be defined in the [Differential tab of Test Object](#)<sup>□46</sup> prior to testing.

Define the hardware, the routing and wiring and trip commands.

Define the Test time, Voltage output, Trigger config, etc in the "[General](#)"<sup>□97</sup> tab of the main view.

#### Differential Characteristic View

Differential Characteristic view is separated by the fault type and automatically linked to the currently selected fault type.

Place the focus on the Differential Characteristic view. Hold down and drag the mouse to draw a rectangle to zoom in the selected area.

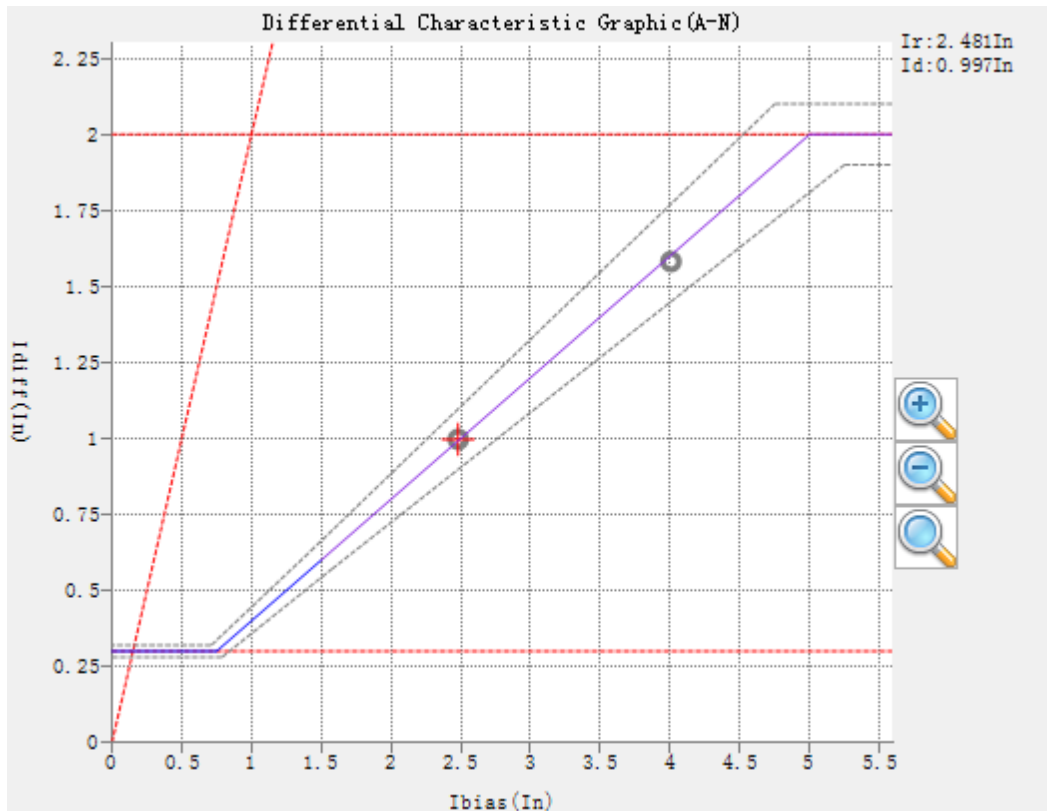

On the right side of the Characteristic, 3 magnifying glasses buttons are provided for quickly zoom in, zoom out, or return to the default view.

#### 1.14.1.1 Shot Test tab

##### Add Test Points

Tests are defined in the Differential Characteristic diagram. Adding test points can be achieved by clicking the "Add" button or manually entering the test point parameters into the input fields "Idiff", "Ibias".

All test points are added to a test table. This table will be automatically sorted by the defined fault type and linked to the Differential Characteristic diagram.

Based on the selected fault type and test points, the voltages or currents at the relay location are calculated automatically and displayed on the Vector View.

Buttons:

Add	Add the defined point to the test table below.
Remove	Delete the currently selected test point from the Test points list.
Remove All	Clear the test list
Check	Perform testing for the currently selected test point.

## Result

In a shot test, all test points assessing whether or not a trip occurs during the test time set at the Diff time settings at the Differential tab of Test Object.

### 1.14.1.2 Search Test tab

#### Add Test Lines

Test lines are defined in the Differential Characteristic diagram. Adding test lines can be achieved by clicking the "Add" button, or entering the test point parameters manually into the input fields "Ibias".

All test lines are added to a test list and linked to the Differential Characteristic diagram.

Each test line consists of several shots. While searching for the line, the Ibias is fixed, the Idiff is calculated and controlled by the module, and the final boundary of the Idiff value is determined by whether it is inside or outside protected zone.

Based on the selected fault type and test points, the voltages or currents at the relay location are calculated automatically and displayed on the Vector View.

Enabling the "Ignore Nominal Characters" option will cover the entire range Idiff scanning from 0 to Idiff>>, this option may need more shot points for each lines.

Reducing the Resolution value can improve the accuracy of the result, but needs more shot points.

Buttons:

Add	Add the defined search line to the test table below.
Add Sweep	Add multiple lines from a starting value to an ending value by a step, the exact lines are automatically calculated.
Remove	Delete the currently selected search line.
Remove All	Clear the test list.
Check	Perform testing on the currently selected test line.

## Result

In a Search test, all test lines assessing the Idiff should be within the tolerance bands set at the Current Tolerances at the Differential tab of Test Object.



### 1.14.1.3 General tab

#### Test Time

Each shot consists of 3 states: Prefault, Max-fault and PostFault.

The Max Fault Time becomes effective only if the shot point has non-tripping time or the tripping time is longer than this Max Fault time and the trigger condition is not met within this time.

By default, Max Fault time and Interval time equal the Max test time and Reset time at the Differential tab of Test Object.

The exact prefault time becomes effective only before the Prefault option is enabled and is set as "Time" mode.

The prefault current only applies in the prefault state.

If the prefault mode is set as GPS trigger, the fault start trigger depends on the GPS time setting, which is usually a PPS or PPM signal.

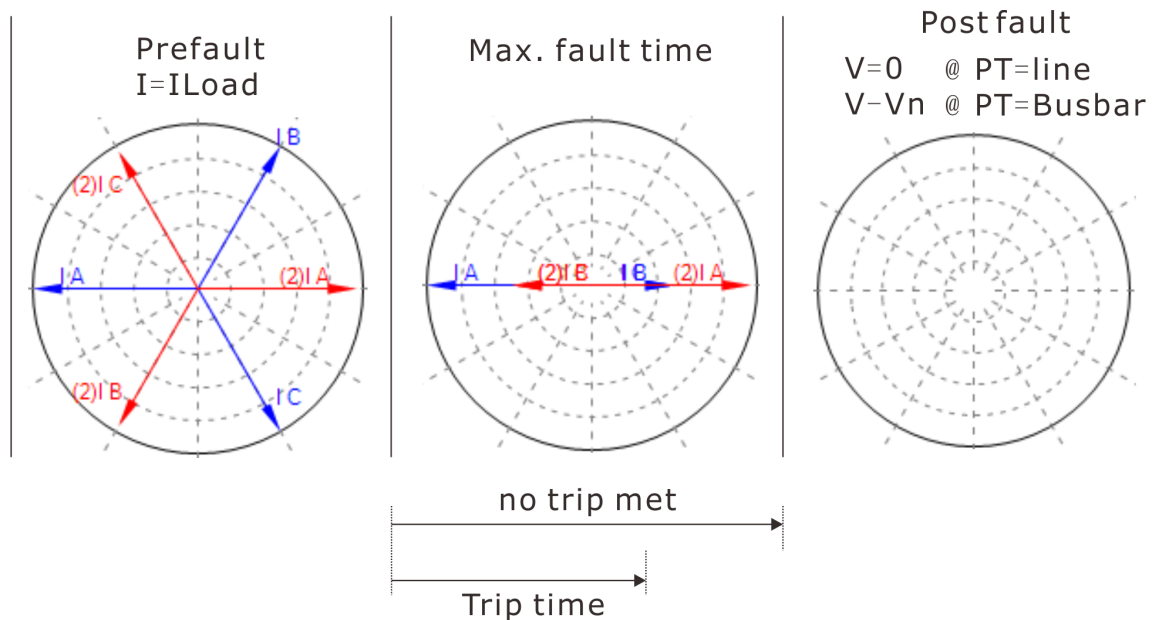

#### Voltage output

Enabling the voltage output option will apply the voltage output to the selected winding.

The presence of voltage in the interval state depends on the location of the PT.

PT=on Line	V <sub>interval</sub> = 0V
PT=on busbar	V <sub>interval</sub> = V <sub>nom</sub>

### 1.14.2 Harmonic Restraint

The Harmonic Restraint module checks the correct relay behavior of the harmonic restraint of the differential function. It contains 2 modes, the "[Shot Test](#)" and "[Search Test](#)".

Each test mode creates a test table. The module will perform the table list determine the shot or search.

For a search line consisting of several shots, the Idiff was given and the Percentage of harmonics is calculated and searched for each search line.

Three currents are required for the Harmonic Restraint test. It is carried out on the reference winding side.

#### Prerequisites for testing

The setting and characteristics of the relay under test have to be defined in the [Differential tab of Test Object](#)<sup>D46</sup> prior to testing.

Define the hardware, the routing and wiring and trip commands.

In the "[General](#)<sup>D100</sup>" tab of main view, define the Test time, Trigger config, etc.

#### Harmonic Restraint Characteristic View

Harmonic Restraint Characteristic view is separated by the Harmonic count.

Place the focus on the Harmonic Restraint Characteristic view. Hold down and drag the mouse to draw a rectangle to zoom in the selected area.

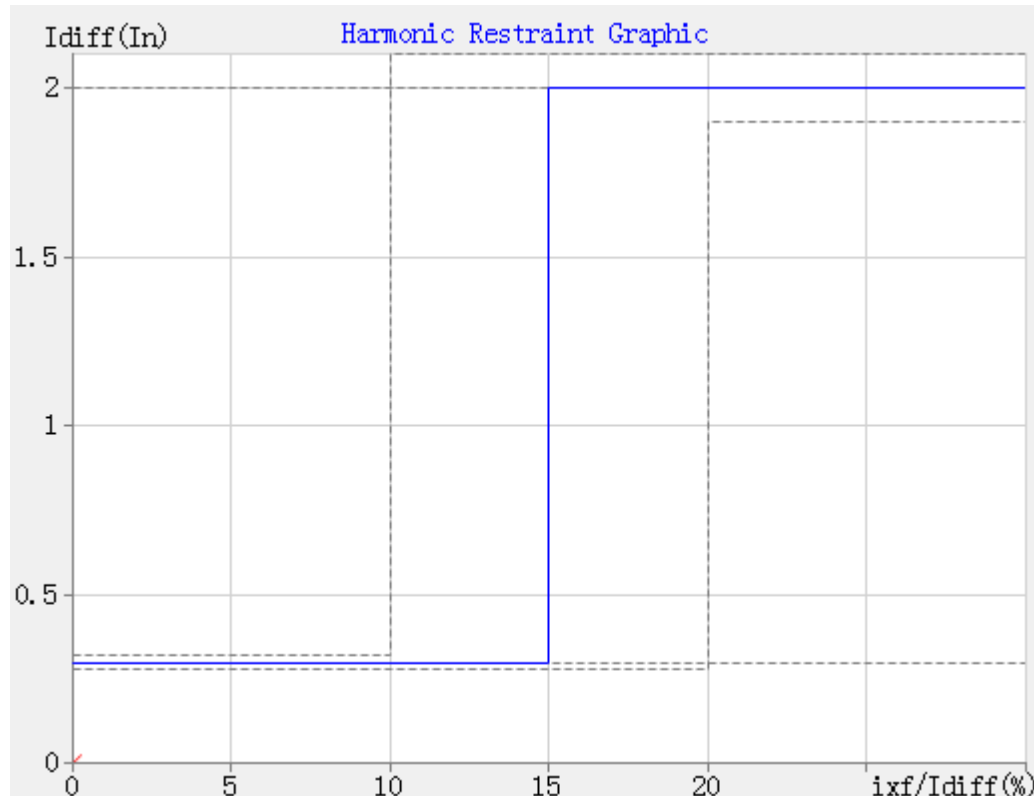

### 1.14.2.1 Shot Test tab

#### Add Test Points

Tests are defined in the Differential Harmonic Characteristic diagram. Select the harmonic count of your choice. Adding test points can be achieved by clicking the "Add" button, or manually entering the test point parameters into the input fields "Idiff", "Ixf/Idiff", "Angle".

Only one harmonic can be tested at a time. You can add more harmonic restraint instances to the current test center for more harmonic counts.

Harmonic with the suffix "N/A" is not available.

All test points are added to a test table. This table will be automatically sorted by the defined fault type and linked to the Differential Harmonic Characteristic diagram.

Based on the selected fault type and test points, the voltages or currents at the relay location are calculated automatically and displayed on the Vector View.

Buttons:

Add	Add the defined point to the test table below.
Delete	Delete the currently selected test point from the Test points list.
Delete All	Clear the test list
Check	Perform testing on the currently selected test point.

#### Result

In a shot test, all test points assess whether or not a trip occurs during the test time set at the Diff time settings at Differential tab of the Test Object.

### 1.14.2.2 Search Test tab

#### Add Test Lines

Test lines are defined in the Differential Harmonic Characteristic diagram. Select the harmonic count of your choice. Adding test lines can be achieved by clicking the "Add" button, or manually entering the test point parameters into the input fields "Idiff".

Only one harmonic can be tested at a time. You can add more harmonic restraint instances to the current test center for more harmonic counts.

Harmonic with the suffix "N/A" are not available.

All test lines are added to a test table and linked to the Differential Characteristic diagram.

Each test line consists of several shots. While searching the line, the Idiff is fixed, the Ixf/Idiff is calculated and controlled by the module, the final boundary of the Ixf/Idiff value is determined from the inside or outside protected zone.

Based on the selected fault type and test points, the currents at the relay location are calculated automatically and displayed on the Vector View.

Enabling the "Ignore Nominal Characters" option will cover the entire range of Ixf/Idiff scanning from 0 to 100%>>, this option may need more shot points for each lines.

Reducing the Resolution value can improve the accuracy of the result but need more shot points. The minimum resolution of the Ixf/Idiff is 0.1%.

Buttons:

Add	Add the defined search line to the test table below.
Add To	Add multiple lines from a starting value to an ending value by a step. The exact lines are automatically calculated.
Delete	Delete the search line for the currently selected test point along of the search line.
Delete All	Clear the test list
Check	Perform testing on the currently selected test line.

Result

In a Search test, all test lines assessing the Ixf/Idiff should be within the tolerance bands set at the Harmonic Tolerances at Differential tab of the Test Object.

### 1.14.2.3 General tab

Test Time Settings

Each shot consists of 3 states: Prefault, Max-fault and PostFault.

The Max Fault Time becomes effective only if the shot point has non-tripping time or the tripping time is longer than this Max Fault time and the trigger condition is not met within this time.

By default, the Max Fault time and Interval time equal the Max test time and Reset time at the Differential tab of Test Object.

The exact prefault time becomes effective only if the Prefault option is enabled.

The prefault current is applied only in the prefault state.

## 1.15 Reclose

This module is used for testing the auto-reclosing processed together with a line protection, which can simulate the before/after state of the reclose state with post-acceleration.

This module uses the Ux channel to simulate the line extracting voltage, allow for setting the amplitude, phase angle and changing the reference channel.

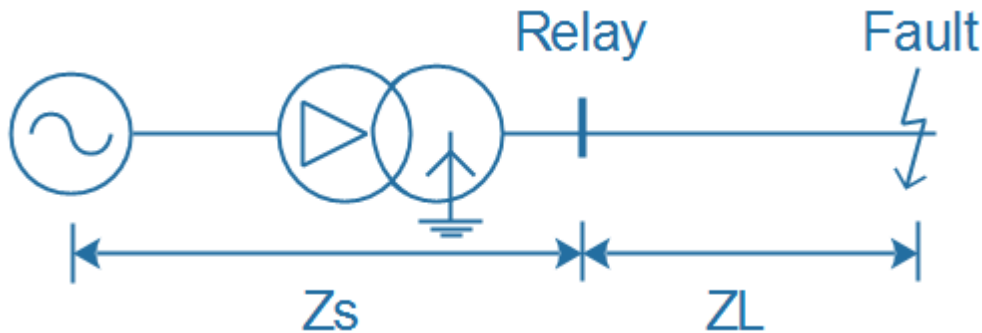

### Prerequisites for testing

The setting and characteristics of the relay under test has to be defined in the [Distance tab of Test Object](#)<sup>143</sup> prior to testing.

Define the hardware, the routing and wiring and trip/reclose commands.

In the "[Parameter](#)"<sup>102</sup> tab of main view, define the Fault Model, Test time, Trigger config, etc.

### 1.15.1 Test

#### Add Test Points

Tests are defined in the impedance plane. Adding test points can be achieved by right clicking on the impedance plane or manually entering the test point parameters into the input fields "|Z|", "Phi", "R", "X".

All test points are added to a test table. This table will be automatically sorted by the defined fault type and linked to the impedance view.

Based on the selected fault type and test points and fault model (I constant / V constant / Z constant), the voltages or currents at the relay location are calculated automatically and displayed on the Vector View.

**Buttons:**

Shot	Add the defined point to the test table below for shot test.
Zone Verify	Quickly add multiple fault types of a defined sequence point for fixed value verification.
Delete	Delete the currently selected test point from the Test points list.
Delete All	Clear the test list
Check	Perform testing on the currently selected test point.

**Options:**

<input type="checkbox"/> Follow line angle change	If active, the impedance of test points will recalculate after the line angle has changed.
<input type="checkbox"/> Relative <input type="text" value="0.000%"/>	If active, the impedance of test points will be calculated by the percentage of the defined zone characteristics.
<input type="checkbox"/> K of DPFC	Setting a fixed value for the coefficient of DPFC relay.
<input type="checkbox"/> Fault Permanent	Enabling this option for permanent fault simulation. The fault still exists after the reclose state. By default, the module is set as the transient mode.

**Result**

All test points given a trip time, reclose time and second trip(post-acceleration) time.

**1.15.2 Fault Transfer**

This tab allows the user to enable a transfer fault impedance and the start reference.

Transfer fault impedance can be manually defined at the input fields "|Z|", "Phi", "R", "X".

Transfer time can define the start reference. It may happen in the first fault state or the reclosed state.

Turn time defines the lag time of the fault after the referenced transfer time.

**1.15.3 Parameters****Test Time**

Each shot consists of 5 states: Prefault, fault state, post-fault, reclosed and post-acceleration.

The exact prefault time becomes effective only if the Fault Trigger mode is set as "Time" mode.

The maximum fault time is limited to the beginning and end of the fault.

The presence of voltage in the post-fault and post-acceleration state depends on the location of the PT.(defined in the [Distance Object](#)<sup>43</sup>)



### Fault Trigger Mode

Define the fault trigger conditions.

Time	Trigger by Prefault time
Key-press	Trigger by keyboard command pressed
{8} Turnover	Trigger by Binary input 8 turnovers
GPS or IRIG-B	Trigger by a GPS or IRIG-B time setting, this is usually a PPS or PPM signal.

### Fault Model

Fault Model include 3 types as below:

I=Constant test current	Fixed test current. The fault voltage is calculated by the module. If the fault voltage is greater than $V_{nom} * 0.9$ , the module will automatically reduce the test current.
U=Constant test voltage	Fixed Test voltage. The fault current is calculated by the module. If the fault current is greater than the $I_{max}$ output, the module will automatically reduce the test voltage.
Z=Constant source impedance	Fixed ZS, the fault current and voltage are calculated by the module. The grounding factor of ZS is defined in the <a href="#">Distance Object</a> <sup>43</sup> .

### Delay Config

The lag time setting can simulate the circuit breaker trip delay and

close delay time if the resulting trigger signal is connected from the circuit breaker.

#### Load Setting

Current	Load current is effective only to the pre-fault state
Phase	Offset angle between the load current and voltage.

#### UX config

Set the Ux channel output during the shot testing.

Custom	This mode allows the user to manually set the Ux output to apply to all states.
+3U <sub>0</sub> , -3U <sub>0</sub> , +√3*3U <sub>0</sub> , - √3*3U <sub>0</sub>	These modes will be applied to all states with the Ux output that are automatically calculated from the 3-phase network.
Sync.VA, ....Sync.VCA	These modes will automatically use the reference channel value as the Ux output and apply it to all states except for the Post-fault state. While in the post-fault state, the Ux setting value will be automatically used according to the reference channel.

#### Fault Inception

This setting allows the use to specify the phase angle of the voltage, and hence the angle of the fault current at the time of fault inception. Before the situation of the fault becomes steady, it is possible to simulate the DC offset transient behavior.

Random	This mode allows the use of a random number generator for the fault inception angle.
Setting	The fault inception angle can be freely adjusted by entering a value in the close angle field.
DC offset	Enabling this option to activate the DC offset transient behavior.
Atten Const	Define the Tconstant of DC offset. During the Tconstant, voltage output is calculated by: $1/(10^{(\Delta t / Tconstant)})$

### 1.15.4 Binary Setting

#### Binary Input Define

The module has predefined the binary input 1/2/3 as single pole or 3 poles. The binary input 4 is defined as the "Reclose" command.

#### Binary Output define

This table allows the user to define the binary output independently. Column explain:

Binary output	Activate the specified binary outputs and set the
---------------	---------------------------------------------------



	initial status. <input type="checkbox"/> Disabled <input checked="" type="checkbox"/> Initial as NO status. <input checked="" type="checkbox"/> Initial as NC status.
Reference mode	1. Reference fault: Binary output turnover function starting from the beginning of fault time. 2. Reference pre-fault: Binary output turnover function starting from the beginning of pre-fault time. 3. Reference input: Binary output turnover function starting from the defined binary input trigger.
Reference binary in	Define the reference binary input channel.
Delay time	Binary outputs after this time will be turnover
Hold time	Keeping this time after the binary output turnover

### 1.15.5 Impedance View

Impedance view is automatically linked to the currently selected fault type according to the different groups of fault types.

The Impedance view always shows the characteristic in secondary value of the relay settings.

The user can pickup a test impedance from the impedance view with the click of a mouse.

After completion of the test, "Passed" points will be displayed in green color, "Failure" points are shown in "red" color.

### 1.15.6 Z/t Characteristic Diagram

At the plane, the Z/t shows the current Z/t characteristics of the test object and all added test points in the same angle of testing list.

## 1.16 Synchronizer

This module aims to perform a synchronism check by simulating an environment to connect a generator to the network or power grid.

### Prerequisites for testing

The setting and characteristics of the synchronizing relay under test have to be defined in the [Synchronizer tab of Test Object](#)<sup>D49</sup> prior to testing.

Define the hardware, the routing and wiring and trip commands.

Select a test item and parameters settings then add to the test table to perform testing.

## Initial parameters setting

System 1 (Vs Side)	This is the reference system. Hence its phase angle is set to 0 degrees. The amplitude and frequency value from the "Device" tab of the test object. The wiring type combo is used to simulate the voltage channels of the power grid by defining the voltage output channels.
System 2 (Vg Side)	This is the generator side. The values are initialized according to the test item. The wiring type combo is used to simulate the voltage channels of the generator by defining the voltage output channels.

## Time setting

Each function test time is limited by the "Max-Sync" time setting.

A Pre-sync time is a period when voltages are outputting before issuing a "Start" binary output signal to the synchronizing relay. At the end of the pre-sync time, the start signal is issued. To obtain this purpose, any one of the binary outputs should be activated and set as "Reference fault" mode.

Delay time is used for "Slips acceleration latch" function and is applicable only when synchronization is obtained between the Vg and Vs sides. During this time period, the KRT will continue to output voltages.

### 1.16.1 Action voltage

This function performs a ramping voltage on the Vg side for the voltage that has not met the synchronization conditions. Each ramping step time is automatically calculated by the difference of frequency between Vg and Vs sides. The synchronized voltage will be returned as the result.

In this function test, the frequency of Vg side must be set as "met the synchronization condition".

A "V step" value defines the ramping voltage range of each steps.

The syncing cycle time is automatically calculated by the module.

Process on Vg side:

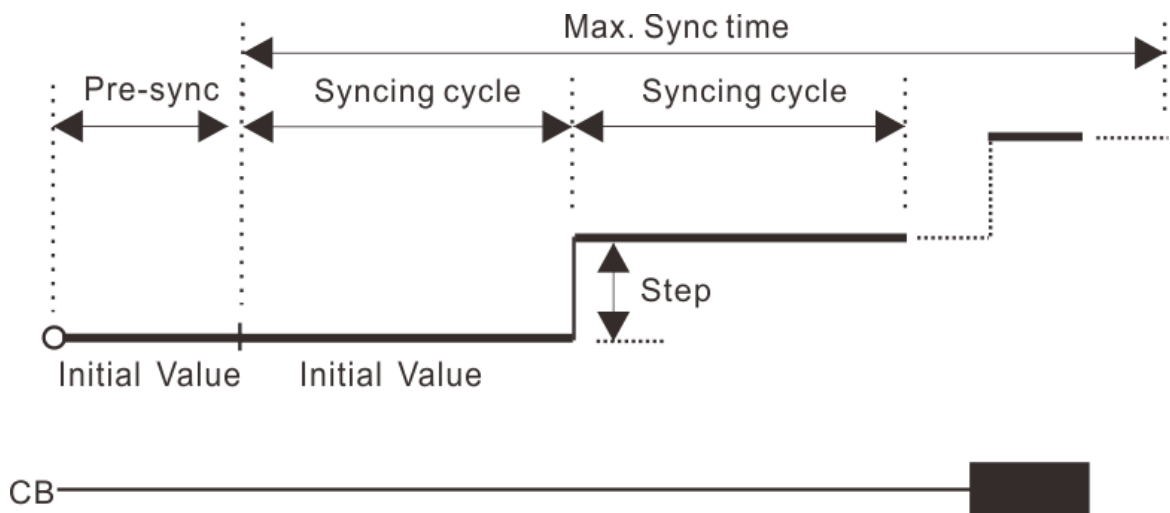

### 1.16.2 Action Frequency

This function performs a ramping frequency on the Vg side for the frequency that has not met the synchronization conditions. Each ramping step time is automatically calculated by the difference of frequency between Vg and Vs sides. The synchronized frequency will be returned as the result.

In this function test, the voltage of Vg side must be set as "met the synchronization condition" or equal to Vs side.

A "F step" value defines the ramping frequency range of each steps.

The syncing cycle time is automatically calculated by the module.

Process on Vg side:

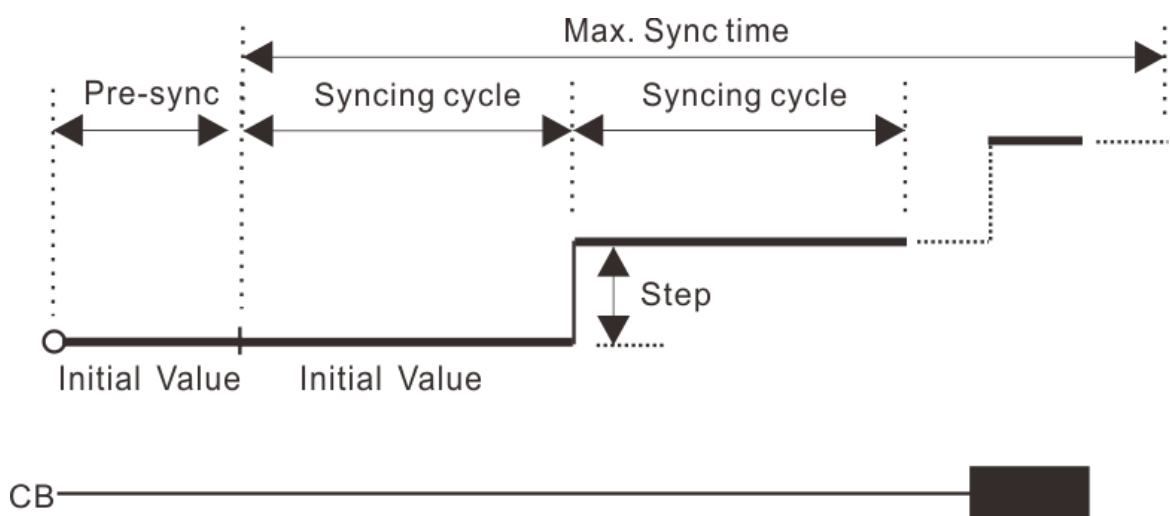

### 1.16.3 Angle / Time

This function performs a ramping frequency on the Vg side for the frequency that has not met the synchronization conditions. Each ramping step time is automatically calculated by the difference of frequency between Vg and Vs sides. The synchronized Lead-Angle and Lead-Time will be returned as the result.

In this function test, the voltage of Vg side must be set as "met the synchronization condition" or equal to Vs side.

A "F step" value defines the ramping frequency range of each steps.

The syncing cycle time is automatically calculated by the module.

Process on Vg side:

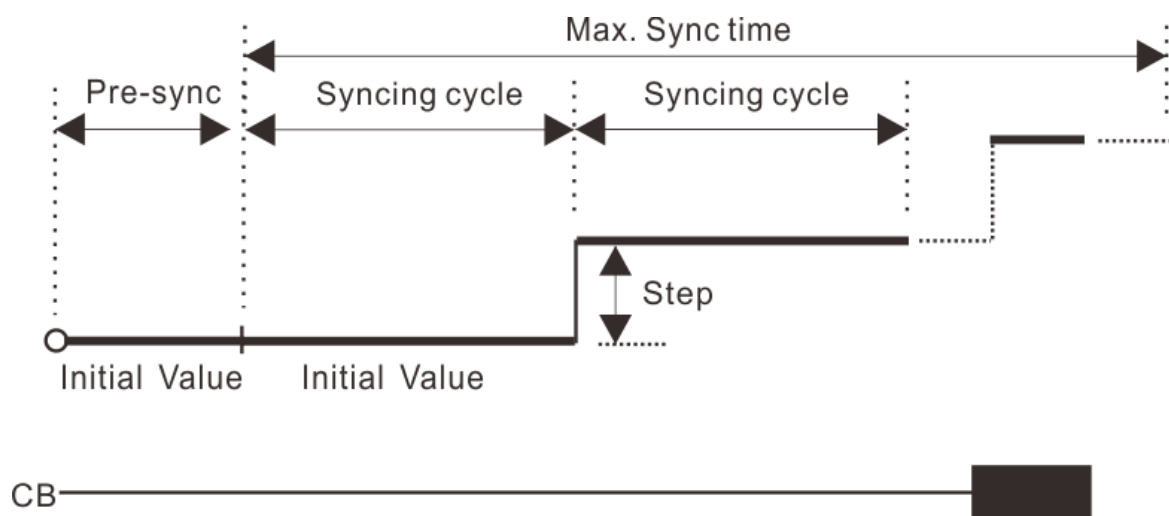

### 1.16.4 Electric Zero

This function performs a fixed outputs test for the Electric Zero type synchronize relay. The synchronized Return-Angle, Action-Angle and Action-Time will be returned as the results.

In this function test, the voltage and frequency of Vg side must be set as met the synchronization conditions and the frequency should not equal to the Vs side.

### 1.16.5 Pulse Width Control-V

This function performs a fixed outputs test for the pulse width of the voltage adjustment signal.

In this function test, the voltage of Vg side should be set as have not met the synchronization conditions.

### 1.16.6 Pulse Width Control-F

This function performs a fixed outputs test for the pulse width of the frequency adjustment signal.

In this function test, the frequency of Vg side should be set as have not met the synchronization conditions.

### 1.16.7 Slips acceleration latch

This function performs a ramping  $df/dt$  on the Vg side, simulating a slips acceleration to test the synchronization relay from an action permitted to latched status. The first latched  $df/dt$  value will be returned as the result.

In this function test, the voltage and frequency of Vg side must be set as have met the synchronization conditions.

The ramping  $df/dt$  value is defined by the "From", "To" and "Step" settings.

The syncing cycle time is automatically calculated by the module.

Process on Vg side:

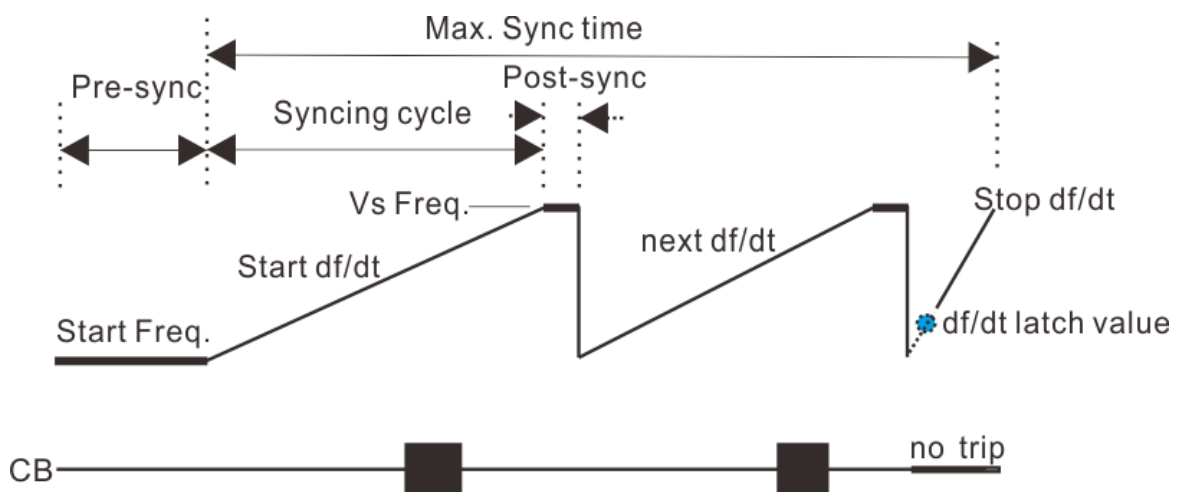

### 1.16.8 Auto Synchronizer

This function performs an automatic adjustment for the synchronization relay, the synchronized Lead-Angle and Lead-Time will be returned as the results.

In this function test, the voltage and frequency of Vg side settings, at least one of them should not have met the synchronization conditions.

The adjustment  $\Delta v/\Delta t$  and  $\Delta f/\Delta t$  values have to be defined.

### 1.16.9 Binary setting

Define of Binary inputs	
Binary inputs: 1~4	CB tripping command from the synchronization relay
Binary input: 5	Voltage increase the adjustment signal
Binary input: 6	Voltage decrease the adjustment signal

### Define of Binary inputs

Binary input: 7	Frequency increase the adjustment signal
Binary input: 8	Frequency decrease the adjustment signal

### Binary outputs (Allow user generate a start/release signal to the synchronization relay)

Binary output	<p>Activate the specified binary outputs and set the initial status.</p> <p><input type="checkbox"/> Disabled</p> <p><input checked="" type="checkbox"/> Initial as NO status.</p> <p><input checked="" type="checkbox"/> Initial as NC status.</p>
Reference mode	<ol style="list-style-type: none"> <li>1. Reference fault: Binary output turnover function starting from the beginning of the fault time.</li> <li>2. Reference prefault: Binary output turnover function starting from the beginning of the prefault time.</li> <li>3. Reference input: Binary output turnover function starting from the defined binary input trigger.</li> </ol>
Reference binary in	Define the reference binary input channel.
Delay time	Binary outputs after this time will be turnover
Hold time	Keeping the time after the binary output has turnover

## 1.17 Power Swing

The power oscillation module simulates the oscillation process of the system and the voltage and current output at the protection installation (K point) when the fault occurs in the system, as shown in the figure below, using a two-terminal transmission system as a model.

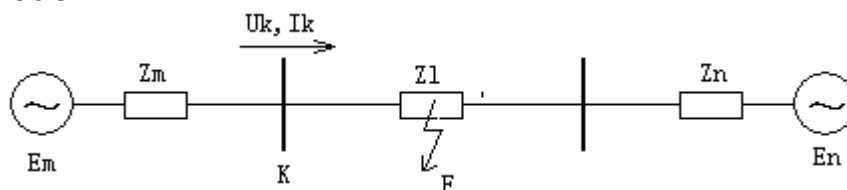

Em: Generator side

En: System side

It is mainly used to analyze the action characteristics of generator out-of-step protection, oscillation de-listing device, and the influence of the system oscillation on the action behavior of line protection such as distance, zero sequence, etc.

### Prerequisites for testing

It is not necessary to set the Test Object prior to testing.

Define the hardware, the routing and wiring and trip commands.

According to the system model, enter the corresponding parameters

into the software "system Model" tab.

Set Test parameters to Software "Test parameters" setting tab

According to the test requirements, choose whether to add the "Fault on oscillate" section.

### 1.17.1 Test Parameter

#### Parameter settings:

Frequency	The output frequency of voltage and current during power angle $\delta$ oscillation; generally set as the rated frequency
Osc. type	The generator side voltage $E_m$ angle $\delta$ oscillation mode, the program provides three ways, including: <b>Swing:</b> The generator angle $\delta$ swings, the power angle $\delta$ starts from the "start angle" and swings between the "start angle" and "end angle". <b>Rotary (CW):</b> the power angle $\delta$ starts from the "start angle" and rotates in the clockwise direction in the $360^\circ$ range. <b>Rotary (CCW):</b> the power angle $\delta$ starts from the "start angle" and rotates in the counter-clockwise direction in the $360^\circ$ range.
Start Angle	Initial angle of oscillation
End Angle	Available only for the swing oscillate type as it represents the stop angle of oscillation
Cycle	The time required to complete 1 cycle of oscillation of the power angle $\delta$ ; <b>Rotary:</b> $0 \sim 360^\circ$ is a cycle; <b>Swing:</b> Start angle $\rightarrow$ End angle $\rightarrow$ Start angle;
Times of Osc.	Sets the number of the power oscillation (that is, the number of sliders)
Pre-fault t.	Output time of the state before oscillation Before entering the oscillation, the tester will first output the pre-oscillation state for a period of time to ensure the protection is reliable. The pre-oscillation state is calculated automatically by the software according to the starting angle of the oscillation and combined with the system model.

#### Fault on oscillate

Fault start time	Fault trigger time, which takes the entry oscillation as the reference point of the time scale.
Fault time	Fault trigger time, which takes the entry oscillation as the reference point of the time scale
Fault type	Seven types of faults are provided: AN, BN, CN, AB, BC, CA, and ABC; Software automatically calculates the voltage and current values of A, B, C three-phase according to

	the setting of the system model and the corresponding fault impedance parameters.
Fault current	Fault short circuit current
Fault impedance	Short circuit point F to protection installation (K point) short circuit impedance $Z_f$ . Polar coordinates form: amplitude, angle

### 1.17.2 System Model

#### System Impedance

Zm	Impedance of the generator side
Zn	Impedance of the system side
Zl	Impedance of the connection line

#### Em/En potential

En	The voltage amplitude of En side; The voltage does not change and the angle is fixed to $0^\circ$ in the oscillation process.
Em/En	A factor used to calculate generator side voltage $E_m$ , $E_m = E_n \cdot \text{factor}$ ; In the oscillation process, the amplitude of the voltage does not change, and the angle $\delta$ oscillates.

#### Oscillate parameters

Center point Z Center point angle	According to the impedance parameters of the system, the out-of-step central impedance is calculated automatically. (representing the impedance of the equivalent power supply within the generator)
Max U, Max I, Min U, Min I	Peak value of the instantaneous Voltage and current in Oscillation process

#### CT/PT

CT polarity:	Dir. Busbar: CT polarity toward busbar is positive, current flow from busbar to line is positive; Dir. Line: CT polarity toward line is positive, current flow from line to busbar is positive;
CT position:	Busbar: Voltage of Post-fault = $V_{nom}$ Line: Voltage of Post-fault = 0V

#### Binary Inputs

Used to receive the relay tripping signals.

#### Binary output

Control the binary outputs turn-over at the beginning of the



oscillation.

Turn time	Flip moment, how long does it take to flip after the test starts.
Hold time	How much time to reset the binary outputs after the turnover have maintained; set to 0 to maintain until the end of the test

### 1.17.3 Surge Diagram

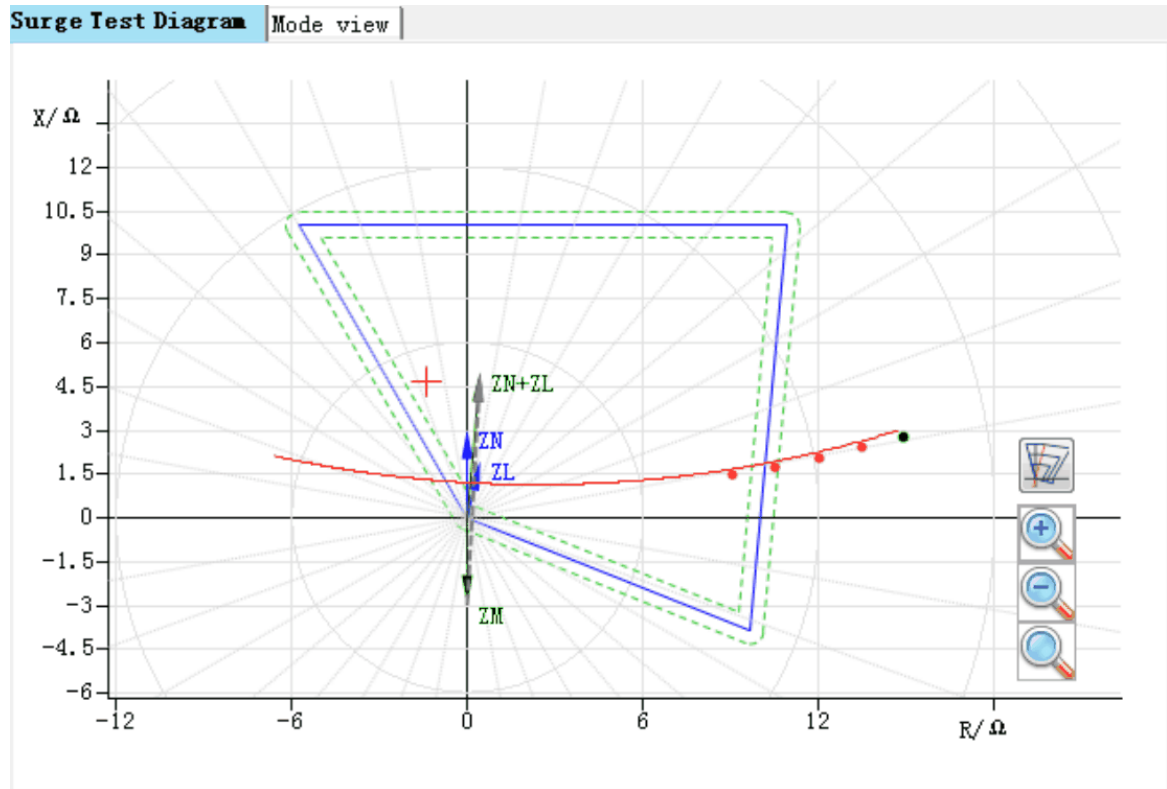

According to the system parameter settings ( $Z_m$ ,  $Z_n$ ,  $Z_l$ ,  $E_n$  and  $E_m/E_n$  factor), software will calculate the swing path line and show on this diagram view. (the red color trace on above). The start angle point is marked as green color.

	Show / Unshown the zone impedance which is defined in the distance object settings.
	Zoom in
	Zoom out.
	Default zoom view.

## 1.18 Energy Meter

This module is used to calibrate the function and accuracy of energy meters.

Prerequisites for testing

It is not necessary to set the Test Object prior to testing;

First, set the energy meter type, pulse constant, CT/PT ratio, pulse type, etc on the "Meter" tab page;

If necessary, you can configure the pulse output constant and whether pulse output is required on the "Settings" page, as well as the heat engine time, startup time during the test process, etc;

Configure hardware type, wiring mode; (The pulse I/O ports refer the hardware introduction of relay test kit)

With reference to the energy meter to be tested, the output parameters are set in the "three-phase equilibrium system" area of the "Test" tab;

Set the number of pulses and deviations for the test and add them to the test list to be tested.

Press "Start(F5)" to start testing, and the software automatically evaluates the test results.

**Note:** Before start testing, please ensure the "Photoelectric conversion sampler" must connected and working well.

Kingsine Electric Automation Co.,Ltd.